

DTM-1 SERIES, 1WATT, 1.5KVDC, ISOLATED, UNREGULATED

FEATURES:

- ✓ 1500Vdc isolation voltage
- ✓ Single and dual output models
- ✓ High efficiency, and low ripple and noise
- ✓ Operating temperature range -40°C to +85°C
- ✓ 3 year warranty



Model	Input voltage (Vdc)	Output voltage (Vdc)	Output current (mA)		Efficiency Typ.
			Min.	Max.	
DTM1-0310	3.3(3.0~3.6)	3.3	30	300	60%
DTM1-0311		5	20	200	68%
DTM1-0312		9	11.1	111	76%
DTM1-0313		12	8.3	83	77%
DTM1-0314		15	6.7	67	78%
DTM1-0321		±5	10	100	70%
DTM1-0322		±9	5.6	56	73%
DTM1-0323		±12	4.2	42	78%
DTM1-0324		±15	3.3	33	79%
DTM1-0510		5(4.5~5.5)	3.3	30	300
DTM1-0511	5		20	200	70%
DTM1-0512	9		11.1	111	76%
DTM1-0513	12		8.3	83	78%
DTM1-0514	15		6.7	67	78%
DTM1-0521	±5		10	100	70%
DTM1-0522	±9		5.6	56	73%
DTM1-0523	±12		4.2	42	77%
DTM1-0524	±15		3.3	33	78%
DTM1-1210	12(10.8~13.2)		3.3	30	300
DTM1-1211		5	20	200	71%
DTM1-1212		9	11.1	111	73%
DTM1-1213		12	8.3	83	80%
DTM1-1214		15	6.7	67	81%
DTM1-1221		±5	10	100	70%
DTM1-1222		±9	5.6	56	73%
DTM1-1223		±12	4.2	42	77%
DTM1-1224		±15	3.3	33	78%
DTM1-1511		15(13.5~16.5)	5	20	200
DTM1-1514	15		6.7	67	80%

DTM-1 SERIES, 1WATT, 1.5KVDC, ISOLATED, UNREGULATED

Model	Input voltage (Vdc)	Output voltage (Vdc)	Output current (mA)		Efficiency Typ.
			Min.	Max.	
DTM1-2411	24(21.6~26.4)	5	20	200	70%

Notes: Other input and output models may available on request.

ELECTRICAL

Line regulation	---	1.5% max.
Load regulation	10% ~ 100% full load	15%max.
Isolation voltage	Leakage current < 1mA/1min.	1500Vdc min.
Isolation resistance	Test at 500VDC	1000mΩ min.
Switching frequency	---	100KHz typ.
Ripple and noise	Bend width 20MHz	150mVp-p max.
Temperature coefficient	Rated load	±0.03%/°C max.
Operating temperature range	---	-40°C to +85°C
Storage temperature range	---	-55°C to +125°C
Short circuit protection	---	1S
MTBF	---	3500KHrs
Weight	---	1.7g

Notes: All the parameters are measured at 25°C ambient temperature, humidity < 75%, nominal input voltage, full load and after warm-up, unless otherwise specified.

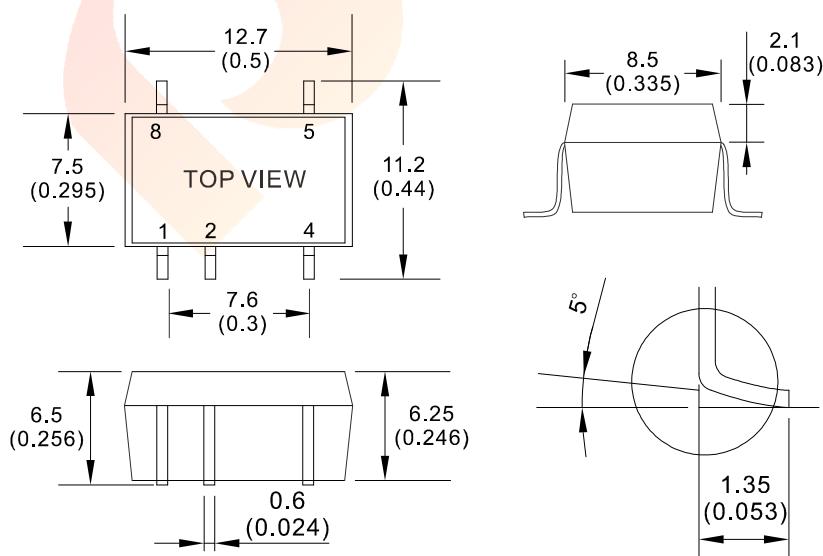
MECHANICAL
Single output

CONNECTION

PIN #	SINGLE	DUAL
1	GND	GND
2	+Vin	+Vin
4	0V	0V
5	+Vo	-Vo
7	No Pin	+Vo
8	NC	No Pin
10	No Pin	NC

Note:

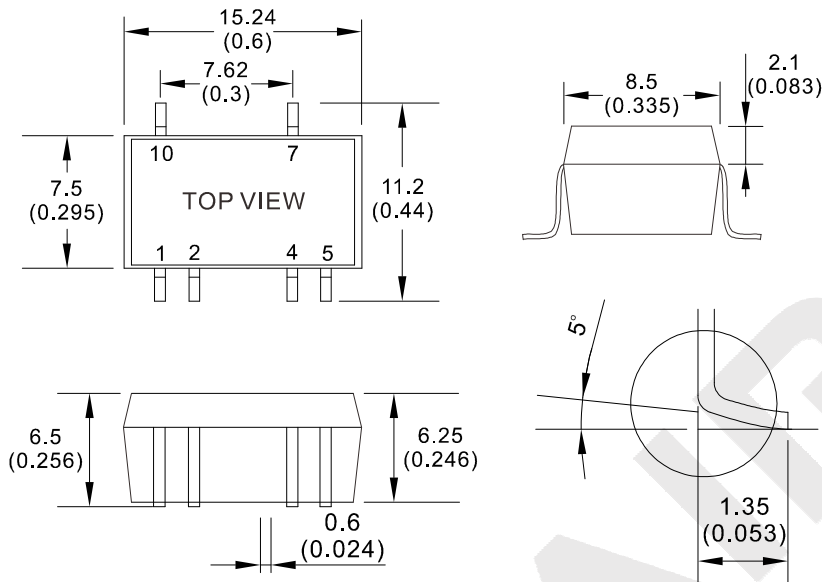
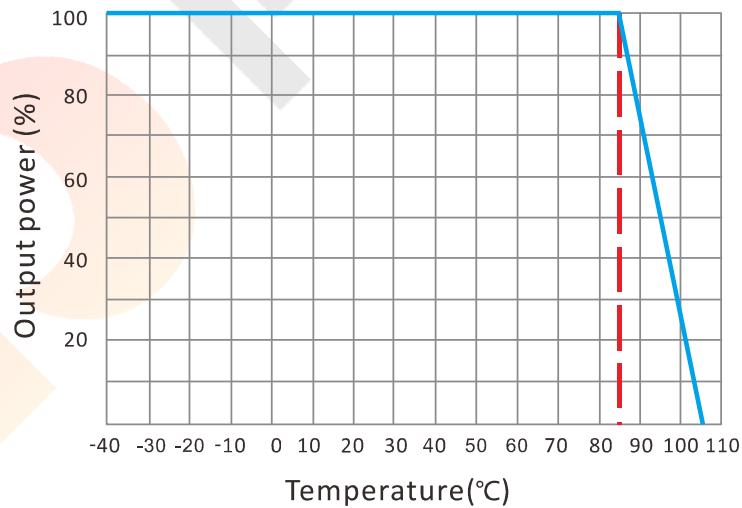
* Unit is mm(inch).

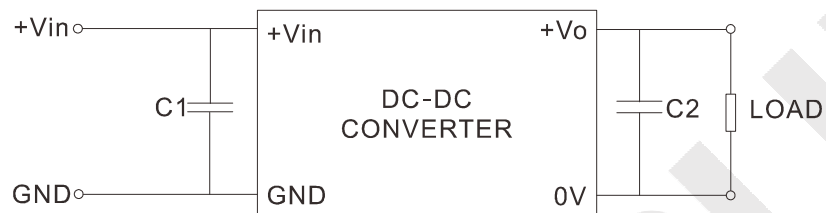
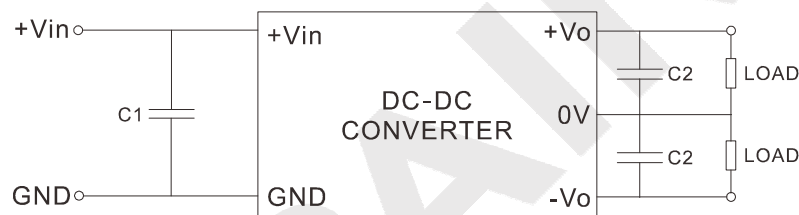
DTM-1 SERIES, 1WATT, 1.5KVDC, ISOLATED, UNREGULATED
MECHANICAL
Dual output

ELECTRICAL CURVE

DTM-1 SERIES, 1WATT, 1.5KVDC, ISOLATED, UNREGULATED
NOTE
RECOMMENDED TEST AND APPLICATION CIRCUIT
SINGLE OUTPUT

DUAL OUTPUT

CAPACITOR SELECTION

INPUT VOLTAGE	C1	SINGLE OUTPUT	C2	DUAL OUTPUT	C2
3.3VDC	4.7 μ F	3.3VDC	10.0 μ F	\pm 5VDC	10.0 μ F
5VDC	4.7 μ F	5VDC	10.0 μ F	\pm 9VDC	4.7 μ F
12VDC	2.2 μ F	9VDC	4.7 μ F	\pm 12VDC	2.2 μ F
--	--	12VDC	2.2 μ F	\pm 15VDC	1.0 μ F
--	--	15VDC	2.2 μ F	--	--