

P/N: FACM16H-393Y0R5

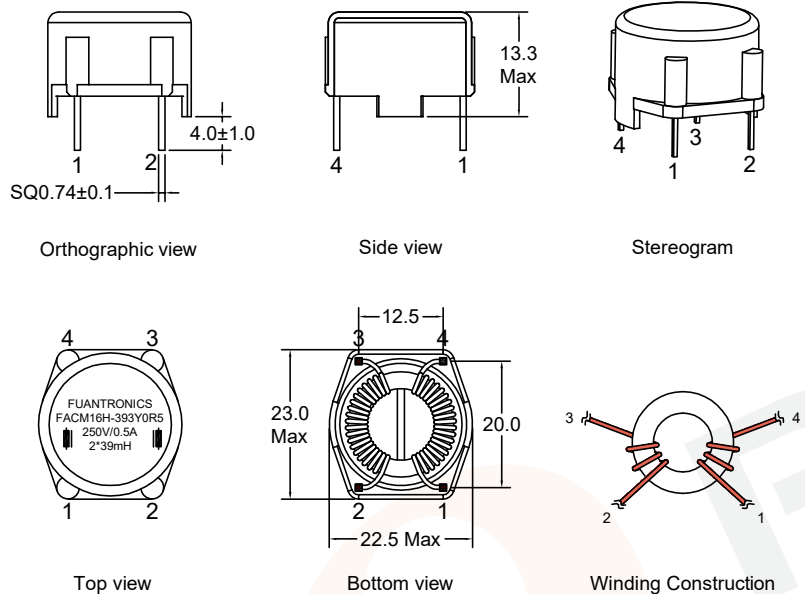

Outline Dimensions(Unit:mm)



Electronical Schematic

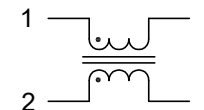

Recommended Soldering Temperature Graph.

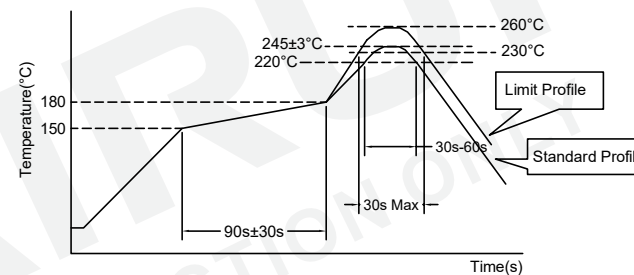

	Standard Profile	Standard Profile
Pre-heating	150~180°C,90s±30s	
Heating	above 220°C,30s-60s	above 240°C,30s Max
Peak temperature	245°C±3°C	260°C, 10s
Cycle of reflow	2 times	

Electrical Characteristics(at 25°C)

Inductance : L1-4=2-3= 39mH +50%/-30%,at 10KHz,0.1V.
 Leakage Inductance: L1-4&2-3= 400uH Typ.
 Rated current: 0.50Amps.
 D.C.Resistance : 1-4= 1.12 ohms Typ.
 2-3= 1.12 ohms Typ.
 Turns Ratio : Coil:Coil= 1:1±2%,at 20KHz,1V.
 Hipot : Coil-Coil : 1500VAC/5mA/2Second.

List of UL Certificate:

Part Name	Mat'l Description	Supplier	UL Number
Case	EB16-002/PA66(orange)	Zhejiang Juner New Materials Co Ltd	E204321
Copper wire	2UEW-F/155C	Elektrisola Hangzhou Co Ltd	E258243
Core	Ferrite core(orange)	Su Zhou Tian Ming Magnetic	N/A
Epoxy	808A-R-B(red soft glue)	Dong Guan Shi Pai Hua Chuang Material Fty	E304477
Spacer	1.00mm/FR-4	Kingboard Laminates Holdings Ltd	E123995

				Tianchang Fuan Electronic Co Ltd www.fuantronics.net TEL: +86-550-7814888 FAX: +86-550-7831133	 Tolerances unless otherwise specified: (X)±0.50 (XX)±0.25 Unit of measurement: mm	Make: Qiumei.Liu Checked: Beson. zhan Approved: Anson. zhan	DRAWING TITLE CURRENT-COMPENSATED RING CORE DOUBLE CHOKES Material Number: A31CM016S310	Customer P/N: Document/Rev: 00 Specification Sheet: 1 of 1 Date of Recognition: Jan./02/2020
REV	DESCRIPTION	APPD	DATE					