

P/N: FACM25BV-183Y3R0

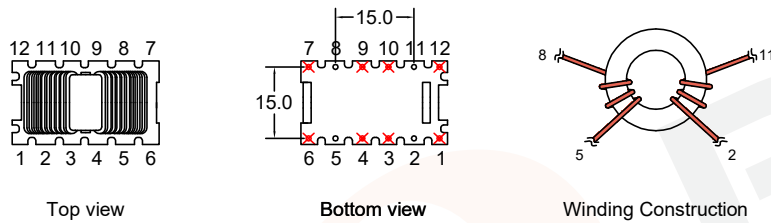

Outline Dimensions(Unit:mm)

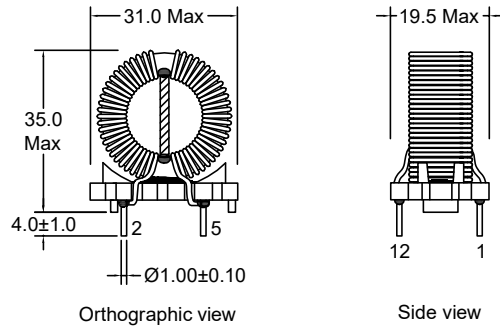

Remarks:
1. Remove pin 1,3,4,6,7,9,10,12.

Electrical Characteristics(at 25°C)

Inductance : L2-11=5-8= 18mH Min,at 10KHz,0.1V.
Rated current: 3.00Amps.
D.C.Resistance : 2-11= 0.130 ohms Typ.
5-8= 0.130 ohms Typ.
Turns Ratio : Coil:Coil= 1:1±2%,at 20KHz,1V.
Hipot : Coil-Coil : 1500VAC/5mA/2Second.

Electronical Schematic

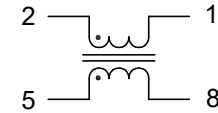

Recommended Soldering Temperature Graph.

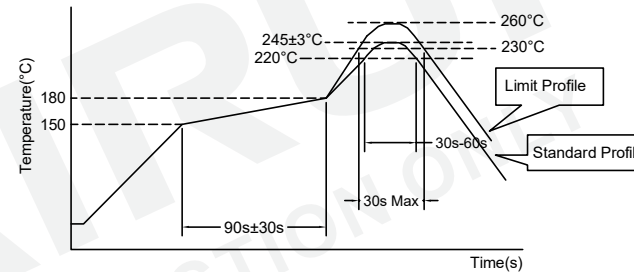

	Standard Profile	Standard Profile
Pre-heating	150~180°C,90s±30s	
Heating	above 220°C,30s-60s	above 240°C,30s Max
Peak temperature	245°C±3°C	260°C,10s
Cycle of reflow	2 times	

List of UL Certificate:

Part Name	Mat'l Description	Supplier	UL Number
Base	Base-009/T375J	Chang Chun Plastics Co Ltd	E59481
Copper wire	2UEW-F/155C	Elektrisola Hangzhou Co Ltd	E258243
Core	Ferrite core(Green)	Su Zhou Tian Ming Magnetic	N/A
Epoxy	E-500	DongGuan Eatto Electronic Material Co Ltd	E218090
Spacer	3.00mm/FR-4	Kingboard Laminates Holdings Ltd	E123995

				Tianchang Fuan Electronic Co Ltd www.fuantronics.net TEL: +86-550-7814888 FAX: +86-550-7831133	Tolerances unless otherwise specified: (X)±0.50 (XX)±0.25 Unit of measurement: mm	Make: Qiumei.Liu Checked: Beson. zhan Approved: Anson. zhan	DRAWING TITLE CURRENT-COMPENSATED RING CORE DOUBLE CHOKES Material Number: A31CM025S100	Customer P/N: Document/Rev: 00 Specification Sheet: 1 of 1 Date of Recognition: Jan./02/2020
REV	DESCRIPTION	APPD	DATE					