

P/N: FALGA0512-561K-T52

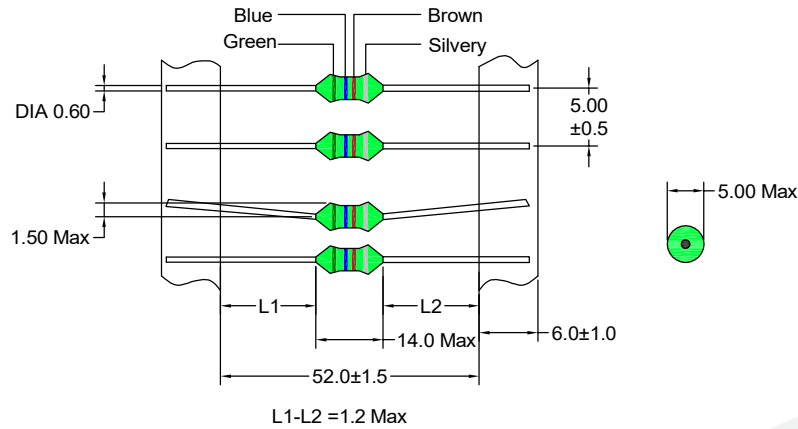

Outline Dimensions(Unit:mm)



\*\*\*Storage temperature(Packing status):-25~+40°C  
 \*\*\*temperature(Component itself):-25~+85°C  
 \*\*\*Storage Humidity:30~70%RH

Electrical Characteristics(at 25°C)

No.	Items	Specification	Measuring point	Test condition	Apparatus
1	Inductance	L0A	560uH ±10%	0.796MHz	HP-4285A
2	Q value		15 Min	0.796MHz	HP-4285A
3	DC Resistance	R	3.85 ohms Max		TH2512B WK6221A
4	Isat	L@0.27A	L0*90%	1KHz/1V	TH2829A

Material list

Part Name	SPEC	Material Type	Supplier	UL Number
Core	DRWW4*8	NiZn	Jiacheng or Equivalent supplier	N/A
Copper Wire	2UEW-F	155°C	Changzhou Dayang Wire & Cable Co Ltd	E158909
Epoxy Paint	DGT-1(green)		Fu Xin or Equivalent supplier	N/A
Epoxy Paint	FK661		QI fu or Equivalent supplier	N/A

Recommended solderability temperature profile.

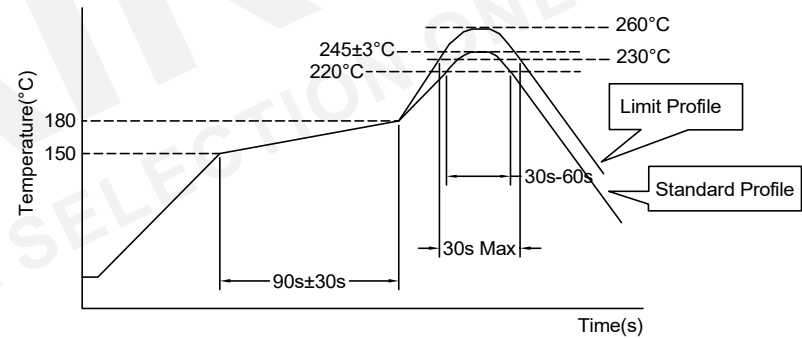

	Standard Profile	Standard Profile
Pre-heating	150~180°C,90s±30s	
Heating	above 220°C,30s-60s	above 240°C,30s Max
Peak temperature	245°C±3°C	260°C,10s
Cycle of reflow	2 times	

## Cautions and Warnings

### 提醒及警告



#### 富安产品范围:

1.FUAN components are manufactured and promoted for applying in general electronics devices such as audio-video equipment, home electric appliance, office automation equipment, communication equipment, power module, LED lighting, measurement hardware, machine accessory, etc.

(本公司的产品使用于影音,家电,办公自动化,通讯,电源模块,LED照明,测量设备,机械工具等一般电子设备中.)

2.If FUAN product will be applied in area like automotive product, medical equipment, military and aerospace except general electronic device, please keep FUAN sales informed in advance. FUAN shall not be held liable for any malfunction or breakdown caused by using product in the condition which is inconsistent with that recommended by FUAN.

(当本公司产品使用在一般电子设备以外的场合,如:车站,医疗设备,军用,航空航天等,请务必联系本公司营业部门,如超出本公司产品使用条件而引起的机器故障时,本公司概不负责.)

3.If there is problem occurring when using product or information on FUAN's catalogue, which may affect industrial property or any other rights of FUAN Group (or a third party), FUAN Group shall not be held liable in such situation, nor grant any license to the offending party.

(在使用本公司的目录上的产品或信息时,如发生涉及到本公司或第三者的产业财产权(工业所有权)以及其他权利的相关问题,本公司恕不负责,亦不授权给侵害方.)

4.Some parts of this publication contain statements about the suitability of our products for certain areas of application. These statements are based on our knowledge of typical requirements that are often placed on our products in the areas of application concerned. We nevertheless expressly point out that such statements cannot be regarded as binding statements about the suitability of our products for a particular customer application.

(在此处指明的一些产品包含有关我们的产品在某些应用领域的适用性陈述.这些陈述是基于我们有关应用领域中经常放在的产品上的典型要求了解.然而,我们明确指出,这些声明不能被视为对某些特殊的客户运用适合的声明.)

5.Generally, FUAN might not be familiar with either customer's specific application or actual requests as customer does. As a result, customer shall be responsible for checking and confirming whether FUAN product with the performance described in the product specification is suitable for using in customer's particular application or not.

(通常情况下,富安不熟悉特定客户的应用,也不熟悉客户本身需求,由于这些原因,客户始终有责任检查并确定具有产品规格中描述的属性的富安产品是否适合在特定客户的应用.)

6.We also have to point out that in individual cases, any trouble or failure of electronic components happens during their long span cannot not be completely cleared even if someone operates according to instruction with existing technology.

(在个案中,我们也要指出,在现有技术中,即使按照规定进行操作,电子元件在其通常使用寿命结束之前发生故障也不能完全排除的.)

7.Please pay attention to the storage conditions that temperature: below 35°C and humidity: 35-65% RH. If product is preserved for more than 1 year, the solderability of their terminals may be deteriorated.

(产品在规定的温度和湿度条件下保存:温度: 35°C以下,湿度: 35-65% RH, 如果保存期超过1年,端子的可焊性可能会变差.)

8.The aforementioned items do not apply to individual agreements and the foregoing customer-specific products.

(上述内容不适用于个人协议和客户上述提到的特定产品.)

#### General instruction for parts usage:

##### 零件使用一般说明:

1. Please pay more attention to the installation position of the non-magnetic shield type coil when you design the printed circuit board to prevent malfunction caused by magnetic interference.

(在设计PCB时,请考虑非磁屏蔽元器件的安装位置,避免磁干扰引起的故障.)

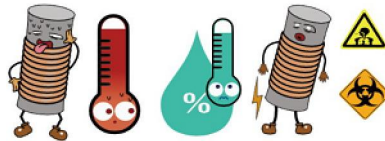

2. Product should not be exposed to environment with high temperature, high humidity, dust, corrosive gas and etc.

(请不要将产品保存在高温/高湿/有灰尘,腐蚀性气体等不适合环境中.)

3.The soldering conditions should also be observed. Temperature mentioned refers to the temperature of wave soldering for PIN or terminals but not the temperature of product itself.

(应留意焊锡条件,说明中如有提及到焊锡温度,是指PIN或端子侵入波峰焊的温度,而不是指产品本体.)

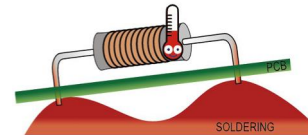
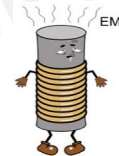

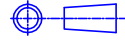
				Tianchang Fuan Electronic Co Ltd www.fuantronics.net TEL: +86-550-7814888 FAX: +86-550-7831133	 Tolerances unless otherwise specified: (X)±0.50 (XX)±0.25 Unit of measurement: mm	Make: Qiumei.Liu Checked: Beson. zhan Approved: Anson. zhan	<b>DRAWING TITLE</b> CAUTIONS AND WARNINGS Material Number:	Customer Name: Document/Rev: Specification Sheet: Date of Recognition:
REV	DESCRIPTION	APPD	DATE					

## Cautions and Warnings

提醒及警告

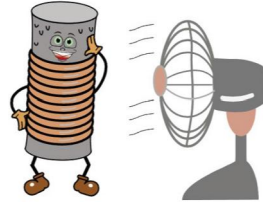

4. Please take the thermal design into consideration when choosing appropriate product, because the coil generates heat when electric current is applied.

(工作时电流通过绕组会产生一定的热量,在选用试请做散热设计之考量.)

5. Please don't use products in a place with dewing. Please be careful when products is applied in a sealed condition since dewing would happen due to temperature change.

(请避免在结露的环境下使用,在密闭环境中,由于温度的变化会导致结露,使用时请注意.)

6. Please always handle products carefully to prevent any damage caused by dropping down or inappropriate removing.

(请小心轻拿轻放,避免由于产品的跌落或取出不当而导致的损坏.)

7. Don't touch electrodes directly with bare hands since oil secretions may do harm to solderability.

(手上有油脂可能导致可焊性下降,请避免手直接接触端子.)

8. Don't bend the terminals with excessive stress in case of any wire fracture.

(端子过度弯曲会导致断线,请不要过度弯曲端子.)

9. Please ensure that all terminals and case lugs are completely fixed onto PCB by soldering, and avoid placing coils near the edge of the PCB.

(请确保所有端子和胶壳足完全焊接到印刷电路板上,尽量避免产品放在印刷电路板边缘.)

10. Don't rinse coils by yourself and please contact FUAN if necessary.

(不要清洗产品,如需要清洗时请联系我司.)

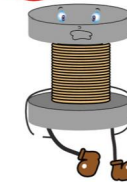

11. Since our SMD coils are designed for automatic mounting, please be careful when soldering manually. Please don't touch any exposed winding part and coil should not be used guiding by electrode in automatic mounting.

(由于表面贴装件都是以自动安装为基准设计,手动焊锡时请注意.产品自动安装,请避免接触卷线露出的部分.另外,不能将端子作为导向使用.)

12. Our specification specifies the quality of the component as a single unit. Please ensure the component is thoroughly evaluated in your application circuit.

(本公司的规格书中只规定了产品的品质,在贵司使用中,请务必确认安装在贵公司产品的状态.)

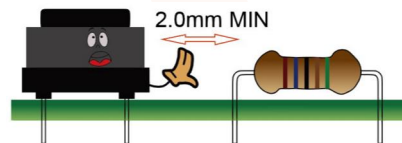

13. When using our high voltage inverter transformers, please place it 2mm away from other electric conductors.

(对于产品高压的逆变变压器,在使用设计时要注意其他导体要离逆变器2mm以上.)

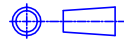
				Tianchang Fuan Electronic Co Ltd www.fuantronics.net TEL: +86-550-7814888 FAX: +86-550-7831133	 Tolerances unless otherwise specified: (X)±0.50 (XX)±0.25 Unit of measurement: mm	Make: Qiumei.Liu Checked: Beson. zhan Approved: Anson. zhan	<b>DRAWING TITLE</b> CAUTIONS AND WARNINGS Material Number:	Customer Name: Document/Rev: Specification Sheet: Date of Recognition:
REV	DESCRIPTION	APPD	DATE					

## Cautions and Warnings

### 提醒及警告



14. The following points must be paid attention to if the components are potted or glued to stick in customer applications:  
(在客户使用时,如果产品被灌封或胶固定,必须注意:)

- Many potting materials shrink as they harden. Therefore, they exert a pressure on the plastic housing or core, which may have a deleterious effect on electrical performance. In extreme cases, it would damage the mechanical performance of core or plastic housing.  
(大部分灌封材料在硬化时都会收缩,因此对塑胶骨架或磁芯施加压力,这种应力作用可以给电气特性带来负面影响,极端情况下可能损坏磁芯或塑胶骨架的机械性能.)
- It is necessary to check whether the potting material used would lead to undesirable performance or break down of insulating layer of enameled wire, plastic bobbin or glue.  
(必须检查使用灌封材料是否会导致漆包线的绝缘层,塑胶骨架或胶水的性能降低甚至损坏.)
- The potting material can affect the high-frequency behavior of components.  
(灌封材料的影响可以改变磁性元器件的高频特性.)
- Ferrites are sensitive to direct shock, which might hurt or even break the core.  
(铁氧体对直接冲击是很敏感的,冲击可能导致磁性材料损伤甚至破碎.)
- For non-Alloy or non-coated molded inductors, its surface might become rusted if it was left in the humid environment. However, its electrical performance would not be affected.  
(对于非合金或非涂层模压产品,如果将产品长期放置在潮湿的环境中,产品的表面可能会生锈,但不会影响产品的特性.)
- Even for customer-specific products, conclusive validation of the component in the circuit can only be carried out by customer.  
(即使是客户的特殊产品,决定性的验证组件的电路也只能通过客户执行.)

				Tianchang Fuan Electronic Co Ltd www.fuantronics.net TEL: +86-550-7814888 FAX: +86-550-7831133	 Tolerances unless otherwise specified: (.X)±0.50 (.XX)±0.25 Unit of measurement: mm	Make: Qiumei.Liu Checked: Beson. zhan Approved: Anson. zhan	<b>DRAWING TITLE</b> CAUTIONS AND WARNINGS Material Number:	Customer Name: Document/Rev: Specification Sheet: Date of Recognition:
REV	DESCRIPTION	APPD	DATE					

