

P/N: FASNR3012-R82N2R05

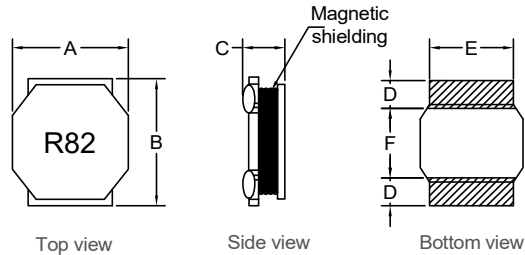

Outline Dimensions(Unit:mm)



A	B	C	D	E	F
±0.20	±0.20	Max	REF	REF	REF
3.00	3.00	1.30	0.90	2.80	1.20



Recommended Soldering Temperature Graph.

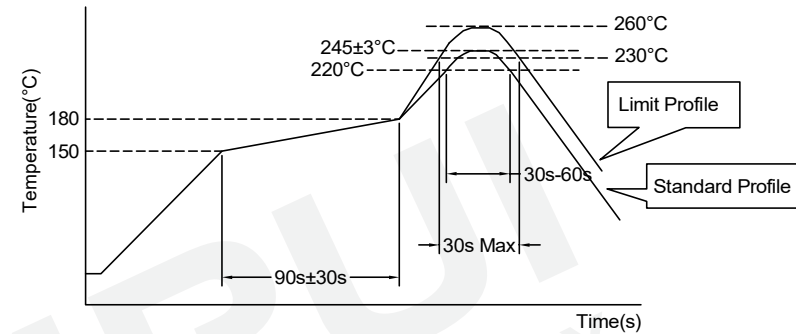

Electrical Schematic



Suggested Pad layout



H	3.00 REF
I	1.30 REF
J	0.90 REF

	Standard Profile	Standard Profile
Pre-heating	150~180°C,90s±30s	
Heating	above 220°C,30s-60s	above 240°C,30s Max
Peak temperature	245°C±3°C	260°C,10s
Cycle of reflow	2 times	2 times

Electrical Characteristics(@25°C)

Inductance 100KHz,0.25V	DC Resistor	Isat (A Max)	Irms (A)ΔT≤40°C
0.82uH±30%	0.050Ω Max	L(2.05A)≥70%*LOA	2.47A

- \*\*\*Operating Temperature: -40°C~+125°C (Including temperature Rise)
- \*\*\*Storage Temperature: -40°C~+125°C
- \*\*\*Storage Humidity:RH10%~70%
- \*\*\*Weight:Approx 0.03g.

				Tianchang Fuan Electronic Co Ltd www.fuantronics.net TEL: +86-550-7814888 FAX: +86-550-7831133	 Tolerances unless otherwise specified: (.X)±0.50 (.XX)±0.25 Unit of measurement: mm	Make: Qiumei.Liu Checked: Beson. zhan Approved: Anson. zhan	<b>DRAWING TITLE</b> SMD POWER INDUCTORS Material Number: A343012XS010	Customer Name: Document/Rev: 00 Specification Sheet: 1 of 4 Date of Recognition: Jan./02/2020
REV	DESCRIPTION	APPD	DATE					

P/N: FASNR3012-R82N2R05



Packing Specifications(Unit:mm):

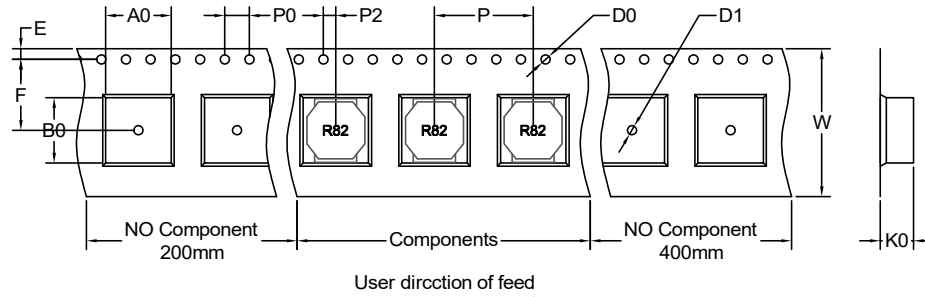

A0	3.20	F	3.50
B0	3.20	D0	1.50
P	4.00	D1	1.50
P0	4.00	K0	1.30
P2	2.00	W	8.00
E	1.75		

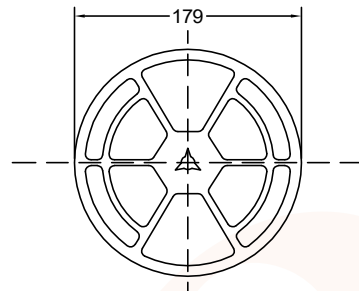

Quantity:2000pcs/Reel

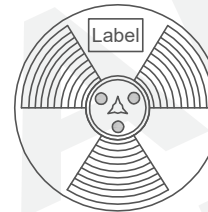

Quantity: 2000pcs

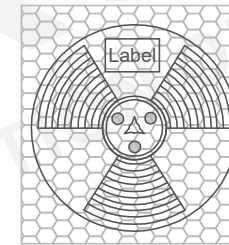

PE bag



Outer cases: 80000pcs/box  
Insufficient boxes filled with inner boxes or fillers

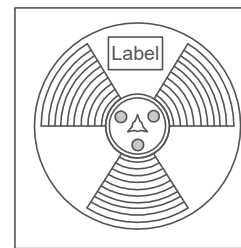

Inner box  
Quantity: 8000 pcs/box

REV	DESCRIPTION	APPD	DATE
-----	-------------	------	------

Tianchang Fuan Electronic Co Ltd  
www.fuantronics.net  
TEL: +86-550-7814888  
FAX: +86-550-7831133

Tolerances unless otherwise specified:  
(.X)±0.50 (.XX)±0.25  
Unit of measurement: mm

Make: Qiumei.Liu  
Checked: Beson. zhan  
Approved: Anson. zhan

**DRAWING TITLE**  
SMD POWER INDUCTORS  
Material Number: A343012XS010

Customer Name:  
Document/Rev: 00  
Specification Sheet: 2 of 4  
Date of Recognition: Jan./02/2020

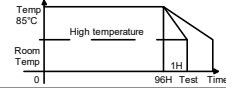
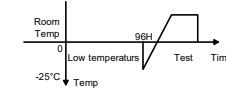
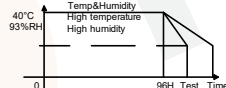
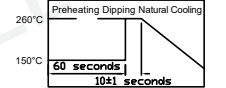

Reliability Testing:

Ltem	Specified value	Test methods
High temperature Storage test Reference documents: MIL-STD-202G Method 108A	1.No case deformation or change in appearance. 2. $\Delta L/L \leq 10\%$ . 3. $\Delta Q/Q \leq 30\%$ . 4. $\Delta DCR/DCR \leq 10\%$ .	Temperature: $85 \pm 2^\circ\text{C}$ Time: $96 \pm 2$ hours. Tested not less than 1 hour, not more than 2 hours at room temperature. 
Low temperature Storage test. Referencedocuments: IEC 68-2-1A 6.1 6.2	1.No case deformation or change in appearance. 2. $\Delta L/L \leq 10\%$ . 3. $\Delta Q/Q \leq 30\%$ . 4. $\Delta DCR/DCR \leq 10\%$ .	Temperature: $25 \pm 2^\circ\text{C}$ Time: $96 \pm 2$ hours. Tested not less than 1 hour, not more than 2 hours at room temperature. 
Humidity test Reference Documents: MIL-STD-202G Method 103B	1.No case deformation or change in appearance. 2. $\Delta L/L \leq 10\%$ . 3. $\Delta Q/Q \leq 30\%$ . 4. $\Delta DCR/DCR \leq 10\%$ .	1.Dry oven at a temperature of $40^\circ \pm 5^\circ\text{C}$ for 24 hours. 2.Measurements At the end of this period 3.Exposure:Temperature: $40 \pm 2^\circ\text{C}$ , Humidity: $93 \pm 3\% \text{RH}$ Time: $96 \pm 2$ hours. 4.Tested while the specimens are still in the chamber. 5. Tested not less than 1 hour, nor more than 2 hours at room temperature. 
Heat endurance of Reflow soldering	1.No case deformation or change in appearance. 2. $\Delta L/L \leq 10\%$ . 3. $\Delta Q/Q \leq 30\%$ . 4. $\Delta DCR/DCR \leq 10\%$ .	Preheat: $150^\circ\text{C}$ ,60 second. Solder:Sn/Ag/Cu. Solder:Temperature: $260 \pm 5^\circ\text{C}$ . Flux:Rosin flux. Reflow peak time 10 second at $260^\circ\text{C}$ 

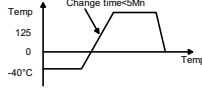
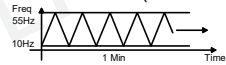
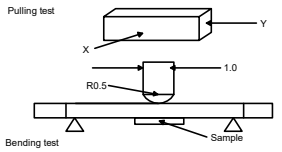
Ltem	Specified value	Test methods
Thermal shock test Reference documents: MIL-STD-202G Method 107G	1.No case deformation or change in appearance. 2. $\Delta L/L \leq 10\%$ . 3. $\Delta Q/Q \leq 30\%$ . 4. $\Delta DCR/DCR \leq 10\%$ . For T:weiges $\leq 28\text{g}$ :15 Min 28g $\geq$ weights $\leq 136\text{g}$ :30 Min	First- $40^\circ\text{C}$ for T time,next+ $125^\circ\text{C}$ Ttime as 1 cycle. Go through 20 cycles. 
Solderability test Reference documents: MIL-STD-202G Method 208H IPC J-STD-002B	Terminals area must have 95% Min. Solder coverage.	Dip pads in flux then dip in solder pot at $245 \pm 5^\circ\text{C}$ for 5 second. Soler:Sn(93.5)Ag(3.5). Flux:Rosin flux.
Vibration test Reference documents: MIL-STD-202G Method 201A	1.No case deformation or change in appearance. 2. $\Delta L/L \leq 10\%$ . 3. $\Delta Q/Q \leq 30\%$ . 4. $\Delta DCR/DCR \leq 10\%$ .	Apply frequency 10~55Hz. 0.75mm amplitude in each of perpendicular direction for 2 hours.(total 6 hours). 
Drop test Reference documents: MIL-STD-202G Method 203G	1.No case deformation or change in appearance. 2. $\Delta L/L \leq 10\%$ . 3. $\Delta Q/Q \leq 30\%$ . 4. $\Delta DCR/DCR \leq 10\%$ . For T:weiges $\leq 28\text{g}$ :15 Min 28g $\geq$ weights $\leq 136\text{g}$ :30 Min	Packaged & Drop down from 1m with $981\text{m/s}^2$ (100G)attitude in 1 angle 1 ridges & 2 surfaces orientations.
Terminal strength push test Reference documents: JIS C 5321:1997	Pulling test: DEFINE:A:sectional area of terminal $A \leq 8(\text{Sq M})$ Force $\geq 5\text{N}$ time:30sec $8(\text{Sq M}) < A \leq 20(\text{Sq M})$ Force $\geq 10\text{N}$ time:10sec $20(\text{Sq M}) < A$ force $\geq 20\text{N}$ time:10sec Bending test: Soldering the products on PCB,after the pulling testand bending test, terminal should not pull off	Bend the testing PCB at middle point, the deflection shall be 2mm 

REV	DESCRIPTION	APPD	DATE	Tianchang Fuan Electronic Co Ltd www.fuantronics.net TEL: +86-550-7814888 FAX: +86-550-7831133	Tolerances unless otherwise specified: (.X) $\pm 0.50$ (.XX) $\pm 0.25$ Unit of measurement: mm	Make: Qiumei.Liu Checked: Beson. zhan Approved: Anson. zhan	<b>DRAWING TITLE</b> SMD POWER INDUCTORS Material Number: A343012XS010	Customer Name: Document/Rev: 00 Specification Sheet: 3 of 4 Date of Recognition: Jan./02/2020
-----	-------------	------	------	---	---	---	--	--

P/N: FASNR3012-R82N2R05



Ltem	Specified value	Test methods
Resistance to solvent test Reference documents: IEC 68-2-45:1993	No case deformation or change in appearance, or obliteration of marking	To dip parts into IPA solvent for 5±0.5Min, then drying them at room temp for 5 Min, at last, to brushing making 10 times.
Electronic characteristic test of major products	Refer to catalogue of specific products	Refer to catalogue of specific products
Overload test Reference documents:	1. During the test no smoke, no peculiar, smell, no fire	Apply twice as rated current for 5 minutes.

Recommended solderability temperature profile:

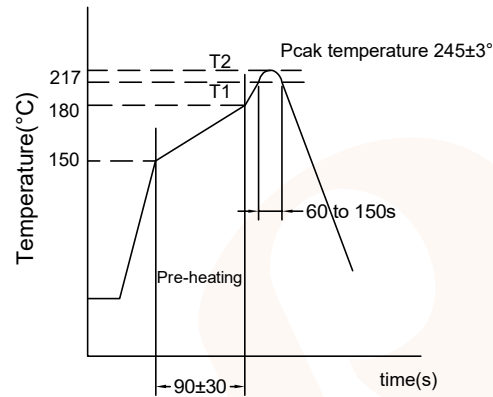

Use rosin-based flux  
Don't use high acidic flux with halide content exceeding 0.2(wt)% (chlorine conversion value).  
Use lead-free solder, use Sn-3.0Ag-0.5Cu solder  
Standard thickness of solder paste: 0.12-0.15mm

				Tianchang Fuan Electronic Co Ltd www.fuantronics.net TEL: +86-550-7814888 FAX: +86-550-7831133	 Tolerances unless otherwise specified: (.X)±0.50 (.XX)±0.25 Unit of measurement: mm	Make: Qiumei.Liu Checked: Beson. zhan Approved: Anson. zhan	<b>DRAWING TITLE</b> SMD POWER INDUCTORS Material Number: A343012XS010	Customer Name: Document/Rev: 00 Specification Sheet: 4 of 4 Date of Recognition: Jan./02/2020
REV	DESCRIPTION	APPD	DATE					