

P/N: FAT74015

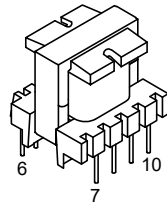

Outline Dimensions (Unit:mm)

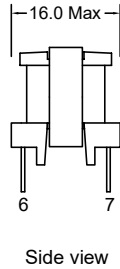
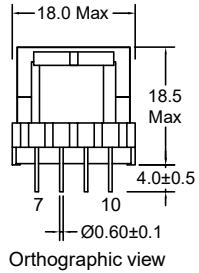

Stereogram

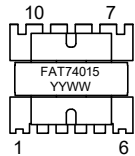

Top view

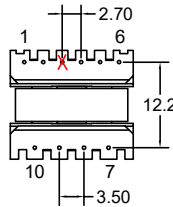

Bottom view

REMARK:

1. Fixed Core With 2Ts Tape.
2. Remove pin3.
3. Product vacuum impregnation.

Electrical Schematic

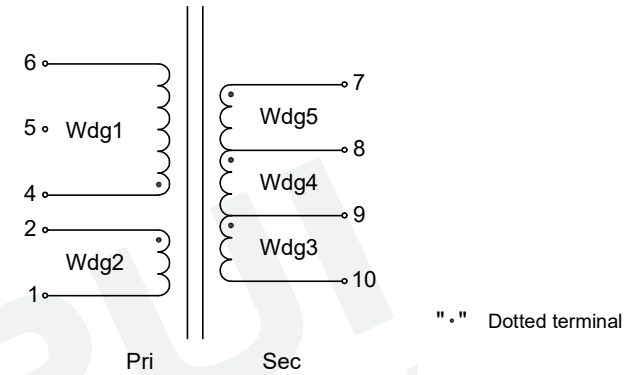

"." Dotted terminal

General Properties:

- Operating Temperature: -40°C to +105°C.
- Storage Temperature: -25°C to +85°C.
- Insulation Class: B.

Wave Soldering

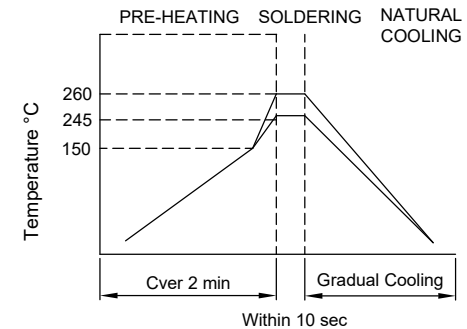

Note:

1. Never Contact the ceramic with the iron tip:
2. 1.0mm tip diameter(max).

Electrical Characteristics

- Inductance : L4-6= 1.80mH ±10%, at 1KHz, 0.3V.
- D.C. Resistance : 1-2= 0.40 ohms Max.
- 4-6= 2.80 ohms Max.
- 7-10= 0.40 ohms Max.
- Turns Ratio : Wdg1:Wdg2:Wdg3:Wdg4:Wdg5= 1:0.117:0.05:0.092:0.083±2%, at 20KHz, 1V.
- Hipot : Pri-Sec : 4000VAC/5mA/2S.
- Pri&Sec-Core : 1500VAC/5mA/2S.
- Pri-Aux : 1500VAC/5mA/2S.

| | | | | | | | | |
|-----|-----------------------------|-------|------------|---|--|---|---|---|
| | | | | Tianchang Fuan Electronic Co Ltd www.fuantronics.net TEL: +86-550-7814888 FAX: +86-550-7831133 | Tolerances unless otherwise specified: (.X)±0.50 (XX)±0.25 Unit of measurement: mm | Make: Qiumei.Liu Checked: Beson. zhan Approved: Anson. zhan | DRAWING TITLE EE16 FLYBACK TRANSFORMER Material Number: A2174015S000 | Customer P/N: Document/Rev: 1011032/00 Specification Sheet: 1 of 2 Date of Recognition: Aug./04/2020 |
| 00 | Release of the new edition. | Beson | 2020.08.04 | | | | | |
| REV | DESCRIPTION | APPD | DATE | | | | | |

P/N: FAT74015



List of UL Certificate:

| No. | Part Name | Mat'l Description | Supplier | UL Number |
|-----|-----------------------|------------------------------|--|-----------|
| 1 | Bobbin | EI-1616/T375J/FAY01091 | Chang Chun Plastics Co Ltd | E59481 |
| | | | | |
| 2 | Copper wire | 2UEW-F/155C | Dong Guan YiDa Industrial Co Ltd | E344055 |
| | | 2UEW-F/155C | Elektrisola Hangzhou Co Ltd | E258243 |
| 3 | Triple insulated wire | TIW-B/130C | Shanghai SuRan Electronic Technology Co Ltd | E335392 |
| | | TRW-B/130C | Great Leoflon Industrial Co Ltd | E211989 |
| 4 | Core | EE16/15/5 HPP4 | Anhui Hualin Magnetic Technology Go Ltd | N/A |
| | | EE16/15/5 GP4 | Su Zhou Guanda Magnet Co Ltd | N/A |
| 5 | Tape | JY25-A(b)/130C(Faint Yellow) | Jingjiang Jingyi Adhesive Product Co Ltd | E246950 |
| | | CT (b)(g)/130C(Faint Yellow) | JingJiang Yahua Pressure Sensitive Glue Co Ltd | E165111 |
| 6 | Varnish | T-4260(a)/MW80-C | SuZhou TaiHu Electric Advanced Material Co Ltd | E228349 |
| | | | | |

Label:

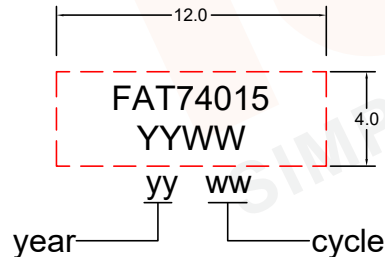

Remark:

1. Use Laser printing;
2. Clear writing and legibility, not easy to erase;
3. Border here means size range, not be printed;
4. Font: Arial; Height: 1.20mm.

| | | | | | | | | |
|-----|-----------------------------|-------|------------|---|--|---|---|---|
| | | | | Tianchang Fuan Electronic Co Ltd www.fuantronics.net TEL: +86-550-7814888 FAX: +86-550-7831133 | Tolerances unless otherwise specified: (.X)±0.50 (XX)±0.25 Unit of measurement: mm | Make: Qiumei.Liu Checked: Beson. zhan Approved: Anson. zhan | DRAWING TITLE EE16 FLYBACK TRANSFORMER Material Number: A2174015S000 | Customer P/N: Document/Rev: 1011032/00 Specification Sheet: 2 of 2 Date of Recognition: Aug./04/2020 |
| 00 | Release of the new edition. | Beson | 2020.08.04 | | | | | |
| REV | DESCRIPTION | APPD | DATE | | | | | |