

P/N: FAT74060

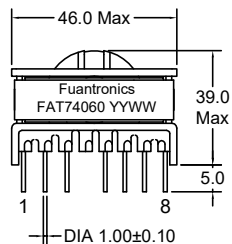

Outline Dimensions(Unit:mm)



Orthographic view

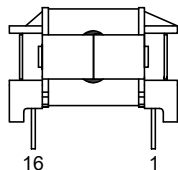

Side view

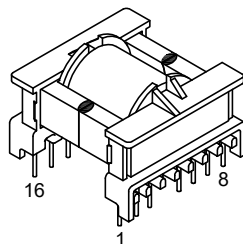

Stereogram

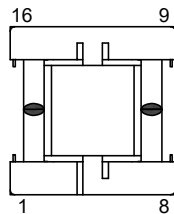

Top view

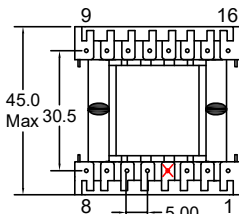

Bottom view

REMARK:

1. Remove Pin4 .
2. Product vacuum impregnation.
3. Fixing of magnetic core with black glue.

Electrical Schematic

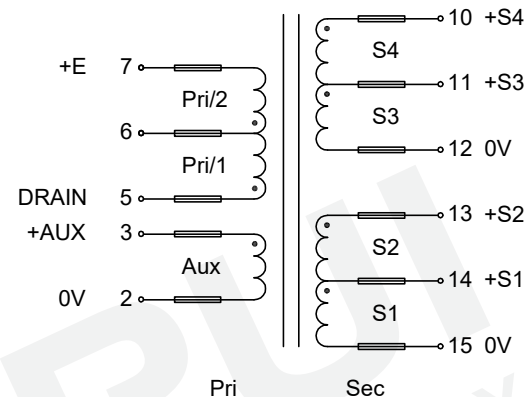

"." Dotted terminal
 — White teflon tube

General Properties:

- Operating Temperature:-40°C to +105°C.
- Storage Temperature:-25°C to +85°C.
- Insulation Class:B.

Wave Soldering

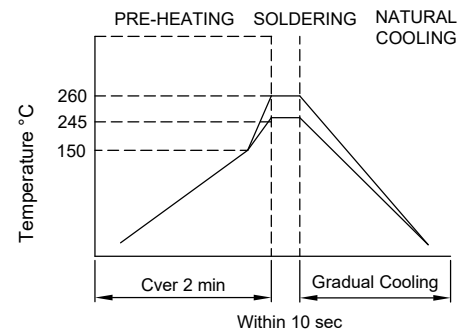

Note:

- 1.Never Contact the ceramic with the iron tip:
- 2.1.0mm tip diameter(max).

Electrical Characteristics

- Inductance : L5-7= 440uH ±10%,at 1KHz,0.3V.
- D.C.Resistance : 3-2= 50.0 mohms Max.
- 5-7= 120 mohms Max.
- 10-12= 14.0 mohms Max.
- 13-15= 15.5 mohms Max.
- Turns Ratio : Pri/1:S4:S3:S2:S1:Pri/2:Aux=18:5:2:5:2:18:4±2%,at 20KHz,1V.
- Hipot : Pri-Sec : 4000VAC/5mA/2S.
- Coil-Core : 1500VAC/5mA/2S.
- Coil-Coil : 500VAC/5mA/2S.

REV	DESCRIPTION	APPD	DATE	Tianchang Fuan Electronic Co Ltd www.fuantronics.net TEL: +86-550-7814888 FAX: +86-550-7831133	 Tolerances unless otherwise specified: (.X)±0.50 (XX)±0.25 Unit of measurement: mm	Make: Qiumei.Liu Checked: Beson. zhan Approved: Anson. zhan	DRAWING TITLE ETD39 FLYBACK TRANSFORMER Material Number: A2174060S000	Customer P/N: Document/Rev: 1206060/00 Specification Sheet: 1 of 2 Date of Recognition: Oct./19/2020
-----	-------------	------	------	---	--	---	--	---

P/N: FAT74060



List of UL Certificate:

No.	Part Name	Mat'l Description	Supplier	UL Number
1	Bobbin	ETD-3901/T385J/FAY01091	Chang Chun Plastics Co Ltd	E59481
2	Copper wire	2UEW-F/155C	Dong Guan YiDa Industrial Co Ltd	E344055
		2UEW-F/155C	Elektrisola Hangzhou Co Ltd	E258243
3	Core	ETD39/40/13 HPP4	Anhui Hualin Magnetic Technology Go Ltd	N/A
		ETD39/40/13 TP4	TDG	N/A
4	Tape	JY25-A(b)/130C(Faint Yellow)	Jingjiang Jingyi Adhesive Product Co Ltd	E246950
		CT (b)(g)/130C(Faint Yellow)	JingJiang Yahua Pressure Sensitive Glue Co Ltd	E165111
5	Margin tape	WF310(a)/130C	Jingjiang Jingyi Adhesive Product Co Ltd	E246950
		WF* (c)(h)/130C	JingJiang Yahua Pressure Sensitive Glue Co Ltd	E165111
6	Tube	CB-TT-L/200°C	ChangYuan Electronics Group Co Ltd	E180908
		CB-TFL/200°C	Dongguan City Changjie Metals & Plastic Products Co Ltd	E338209
7	Epoxy	E-500	Dongguan Eatto Electronic Material Co Ltd	E218090
8	Varnish	T-4260(a)/MW80-C	SuZhou TaiHu Electric Advanced Material Co Ltd	E228349

Label:

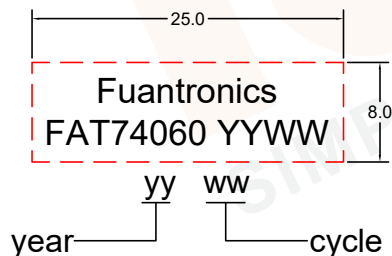

Remark:

1. Use Laser printing;
2. Clear writing and legibility, not easy to erase;
3. Border here means size range, not be printed;
4. Font: Arial; Height: 2.00mm.

				Tianchang Fuan Electronic Co Ltd www.fuantronics.net TEL: +86-550-7814888 FAX: +86-550-7831133	 Tolerances unless otherwise specified: (.X)±0.50 (XX)±0.25 Unit of measurement: mm	Make: Qiumei.Liu Checked: Beson. zhan Approved: Anson. zhan	DRAWING TITLE ETD39 FLYBACK TRANSFORMER Material Number: A2174060S000	Customer P/N: Document/Rev: 1206060/00 Specification Sheet: 2 of 2 Date of Recognition: Oct./19/2020
REV	DESCRIPTION	APPD	DATE					