

P/N: FAT74080

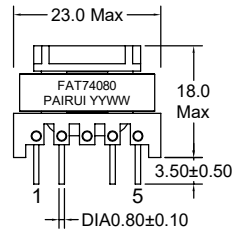

Outline Dimensions(Unit:mm)



Orthographic view

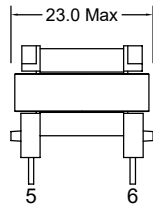

Side view

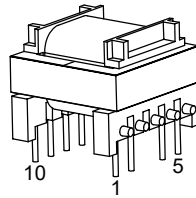

Stereogram

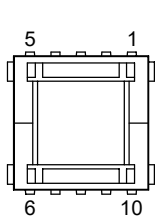

Top view

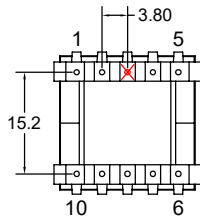

Bottom view

REMARK:

1. Fixed Core With 2Ts Tape.
2. Pin 3 removed.
3. Product vacuum impregnation.

Electronical Schematic

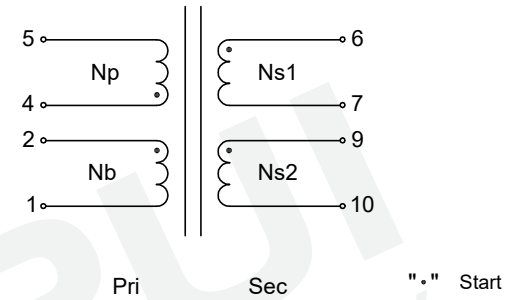

General Properties:

- Operating Temperature:-40°C to +105°C.
- Storage Temperature:-25°C to +85°C.
- Insulation Class:B.

Wave Soldering

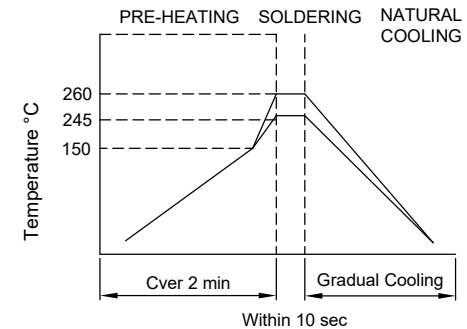

Note:

- 1.Never Contact the ceramic with the iron tip:
- 2.1.0mm tip diameter(max).

Electrical Characteristics

- Inductance : L4-5= 1.00mH ±10%,at 1KHz,0.3V.
- D.C.Resistance : 1-2= 0.20 ohms Max.
- 4-5= 1.30 ohms Max.
- 6-7= 0.060 ohms Max.
- 9-10= 0.060 ohms Max.
- Turns Ratio : Np:Nb:Ns1:Ns2=1:0.139:0.116:0.116±2%,at 20KHz,1V.
- Hipot : Pri-Sec : 4000VAC/5mA/1S.
- Pri&Sec-Core : 1000VAC/5mA/1S.
- Pri-Aux : 1000VAC/5mA/1S.

| | | | | | | | | |
|-----|-------------|------|------|--|--|---|---|---|
| | | | | Tianchang Fuan Electronic Co Ltd www.fuantronics.net TEL: +86-550-7814888 FAX:+86-550-7831133 | | Make: Qiumei.Liu Checked: Beson. zhan Approved: Anson. zhan | DRAWING TITLE EF20 FLYBACK TRANSFORMER Material Number: A2174080S000 | Customer P/N: Document/Rev: 110102300/00 Specification Sheet: 1 of 2 Date of Recognition: Jan./04/2021 |
| REV | DESCRIPTION | APPD | DATE | | Tolerances unless otherwise specified: (.X)±0.50 (XX)±0.25 Unit of measurement: mm | | | |

P/N: FAT74080



List of UL Certificate:

| No. | Part Name | Mat'l Description | Supplier | UL Number |
|-----|-----------------------|------------------------------|--|-----------|
| 1 | Bobbin | EF-2002/T375J/FAY01091 | Chang Chun Plastics Co Ltd | E59481 |
| | | | | |
| 2 | Copper wire | xUEW/155 MW 79-C | JiangSu Dartong M & E Co Ltd | E237377 |
| | | Polysol 155 MW 79-C | Elektrisola Hangzhou Co Ltd | E258243 |
| 3 | Triple insulated wire | TRW-B/130C | Great Leoflon Industrial Co Ltd | E211989 |
| | | | | |
| 4 | Core | EF20/10/6 HPP4 | Anhui Hualin Magnetic Technology Go Ltd | N/A |
| | | EF20/10/6 TP4 | TDG | N/A |
| 5 | Tape | JY25-A(b)/130C(Faint Yellow) | Jingjiang Jingyi Adhesive Product Co Ltd | E246950 |
| | | CT*(b)(g)/130C(Faint Yellow) | JingJiang Yahua Pressure Sensitive Glue Co Ltd | E165111 |
| 6 | Varnish | T-4260(a)/MW80-C | SuZhou TaiHu Electric Advanced Material Co Ltd | E228349 |
| | | | | |

Label:

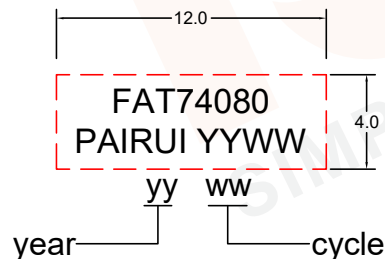

Remark:

- 1.Use Laser printing;
- 2.Clear writing and legibility, not easy to erase;
- 3.Border here means size range, not be printed;
- 4.Font:Arial;Height:1.20mm.

| | | | | Tianchang Fuan Electronic Co Ltd www.fuantronics.net TEL: +86-550-7814888 FAX: +86-550-7831133 | Tolerances unless otherwise specified: (.X)±0.50 (XX)±0.25 Unit of measurement: mm | Make: Qiumei.Liu Checked: Beson. zhan Approved: Anson. zhan | DRAWING TITLE EF20 FLYBACK TRANSFORMER Material Number: A2174080S000 | Customer P/N: Document/Rev: 110102300/00 Specification Sheet: 2 of 2 Date of Recognition: Jan./04/2021 |
|-----|-------------|------|------|---|--|---|---|---|
| REV | DESCRIPTION | APPD | DATE | | | | | |