

MOUNTING CLIP

DRAWING NO:PC-1408

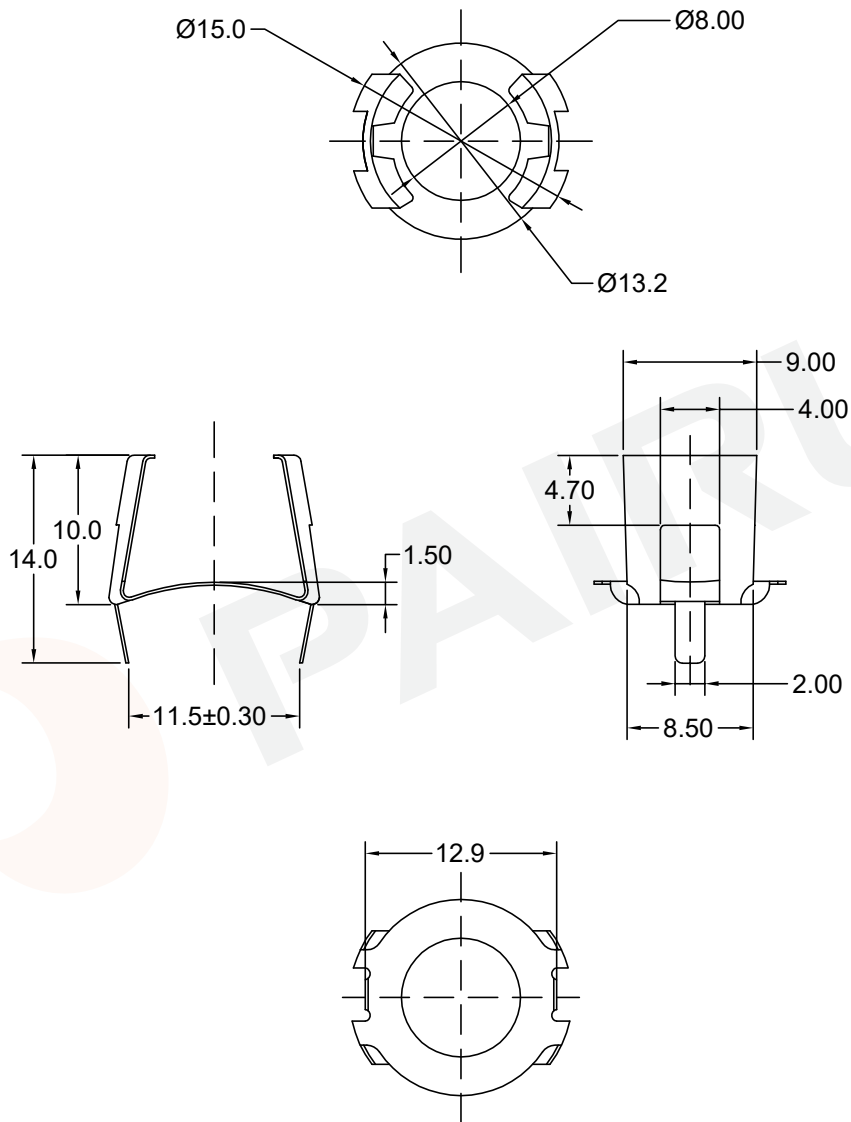

Tolerances unless otherwise specified:
 $0 < L \leq 4 \pm 0.10$ $4 < L \leq 16 \pm 0.20$
 $16 < L \leq 45 \pm 0.30$ $45 \leq L \pm 0.40$
 Wall thickness: 0.30 ± 0.05 Angle: $\pm 1^\circ$

Dimensions:
(mm)

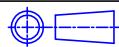

REMARK

Mould No.:	Clip Material: C5191 0.30T
Code No.: FAY01269	UL Recognition:



Fuan Electronics
 TEL :0086-514-87693589
 EML :sales@fuantronics.net
 WEB:www.fuantronics.net

Make: P.Xiao	Material Number: 222PC1408002
Checked: Beson. zhan	Document/Rev: 00
Approved: Anson. zhan	Date of Recognition: Dec./09/2019