

Outline Dimensions(Unit:mm)

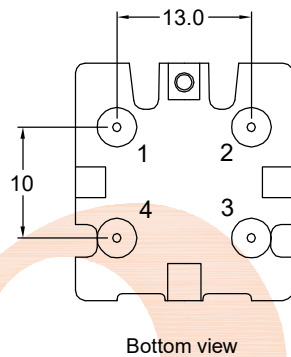

Electronical Schematic

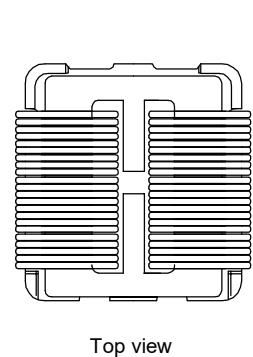
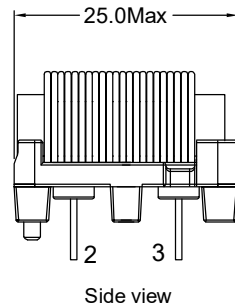
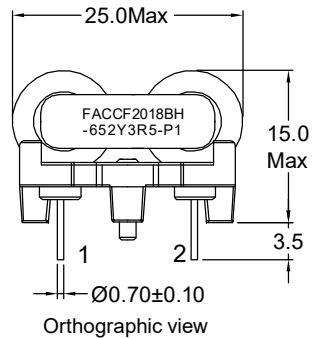
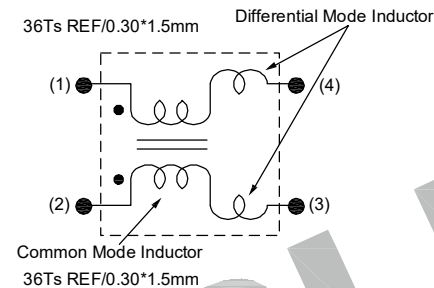

Simulation test curve:

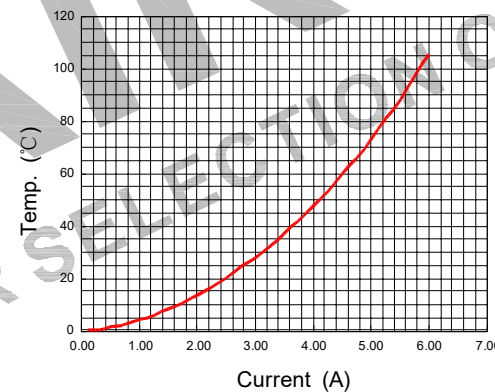

Electrical Characteristics(at 25°C)

- Inductance : 6.5mH Min,at 1KHz,0.25V.
- Lstray: Lkg=95uH typ,at 1KHz,0.25V.
- Inductance balance : L1-L2= 200uH Max,at 1KHz,0.25V.
- D.C.Resistance: 50 mohms Max.
- Rated current: 3.5Amps.
- Turns Ratio : 1:1±2%,at 20KHz,1V.
- Hipot : Pri-Sec : 1500VAC/5mA/2Second.

List of UL Certificate:

Part Name	Mat'l Description	Supplier	UL Number
Bobbin	SQ2018/T375HF	Chang Chun Plastics Co Ltd	E59481
Copper wire	SFT-UJEW-H	Ningbo Jintian New Material Co Ltd	E227047
Core	ETV2018-H12K	Su Zhou Tian Ming Magnetic	N/A
Epoxy	YZ-HC-1401C	YouZhi Electronic(DongGuan)Co.,Ltd	N/A
or Varnish	T4260LZ	Suzhou Taihu Electric Advanced Material Co., Ltd	E228349

***Weight:Approx 21.0g.

REV	DESCRIPTION	APPD	DATE	Tianchang Fuan Electronic Co Ltd www.fuantronics.net TEL: +86-550-7814888 FAX: +86-550-7831133	 Tolerances unless otherwise specified: (.X)±0.50 (.XX)±0.25 Unit of measurement: mm	Make: Yuing.yu Checked: Beson. zhan Approved: Anson. zhan	DRAWING TITLE CCF2018BH Current-compensated frame core double chokes Material Number:	Customer P/N: Document/Rev: 2207494/00 Specification Sheet: 1 of 1 Date of Recognition: July./26/2022
-----	-------------	------	------	---	---	---	---	--