

P/N: FAPE3010136

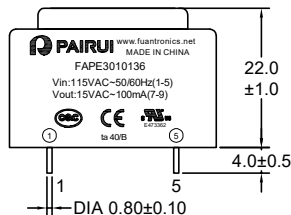

Outline Dimensions(Unit:mm)



Front View

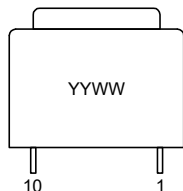

Side View

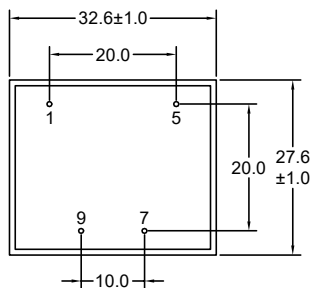

Bottom View

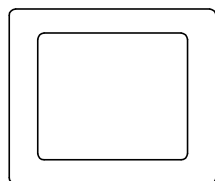

Top View

Note:

1.Remove Pins 2,3,4,6,8,10.

Wave Soldering

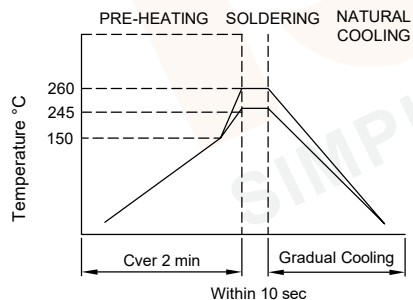

Note:
1.Never Contact the ceramic with the iron tip;
2.1.0mm tip diameter(max).

Electronical Schematic

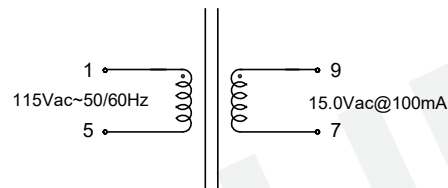

Electrical Characteristics

Input 115Vac 60Hz to 1-5 :
Excitation current(Ix):12.0mA Max.
Output: Vo7-9=25.3Vac Typ(No-load).
VL7-9=15.0Vac±5%(@100mA).
Hi-Pot: Pri-Sec:4000VAC/5mA/60Second.

General Properties

Operating Temperature:-25°C to +40°C.
Storage Temperature:-25°C to +85°C.
Insulation Class: B.

				Tianchang Fuan Electronic Co Ltd www.fuantronics.net TEL: +86-550-7814888 FAX: +86-550-7831133	Tolerances unless otherwise specified: (X)±0.50 (XX)±0.25 Unit of measurement: mm	Make: Qiumei.Liu Checked: Beson. zhan Approved: Anson. zhan	DRAWING TITLE 1.50W Encapsulated Transformer For EI30*10.5,115VAC Input 50/60Hz Material Number: A223010XS870	Customer Name: Document/Rev: 00 Specification Sheet: 1 of 3 Date of Recognition: Jan./02/2020
REV	DESCRIPTION	APPD	DATE					

P/N: FAPE3010136

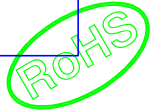

List of UL Certificate:

No.	Part Name	Mat'l Description	Supplier	UL Number
1	Bobbin	EI30*10.5/PBT(Black)	Chang Chun Plastics Co Ltd	E59481
2	Case	CASE-EI30*10.5/PA66(Orange)	Zhejiang Juner New Materials Co Ltd	E204321
3	Copper wire	2UEW-F/155C	Elektrisola Hangzhou Co Ltd	E258243
4	Core	Lamination	Ta Yea Steel Industry Co Ltd	N/A
5	Epoxy	PU552(Black)	Wevo-Chemle Gmbh	E108835
6				

Packaging Specification:

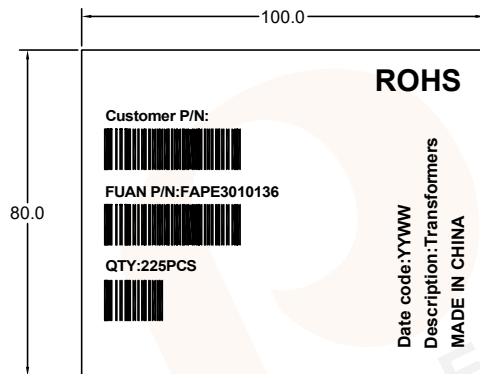

Label of outer

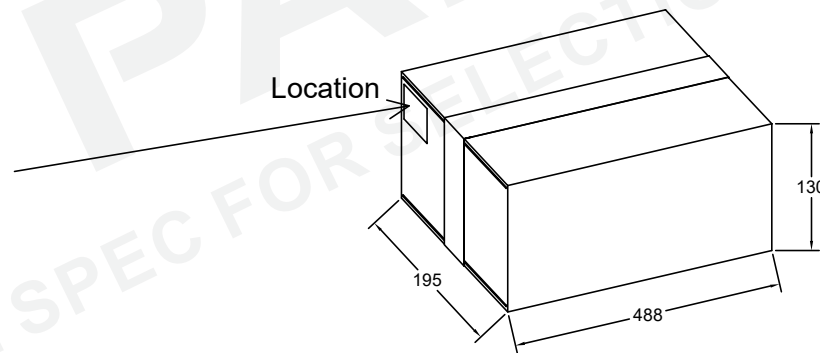

put the label on the top left corner of one of the carton sides

				Tianchang Fuan Electronic Co Ltd www.fuantronics.net TEL: +86-550-7814888 FAX: +86-550-7831133	 Tolerances unless otherwise specified: (.X)±0.50 (XX)±0.25 Unit of measurement: mm	Make: Qiumei.Liu Checked: Beson. zhan Approved: Anson. zhan	DRAWING TITLE 1.50W Encapsulated Transformer For EI30*10.5,115VAC Input 50/60Hz Material Number: A223010XS870	Customer Name: Document/Rev: 00 Specification Sheet: 2 of 3 Date of Recognition: Jan./02/2020
REV	DESCRIPTION	APPD	DATE					

P/N: FAPE3010136

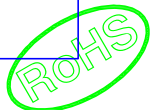

Packing Method:

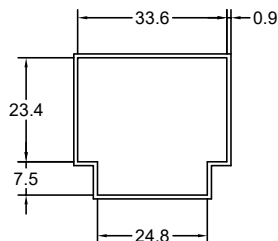
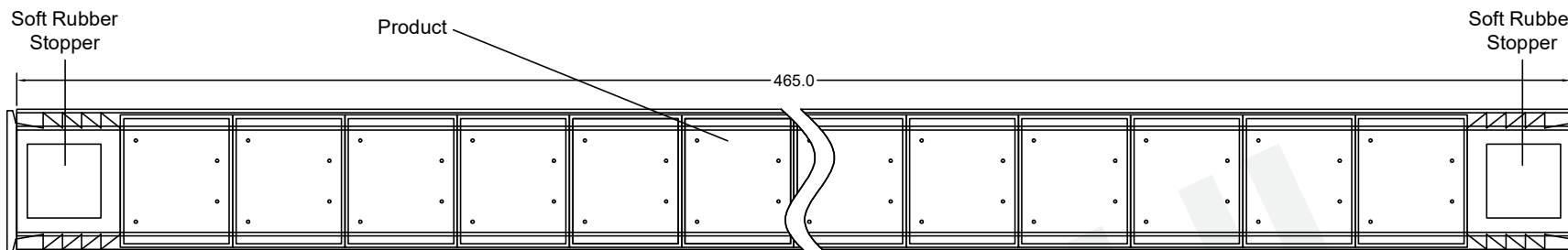

Size of packaging tube:
465mm*35.4mm*32.7mm
(Length * Width * Height)

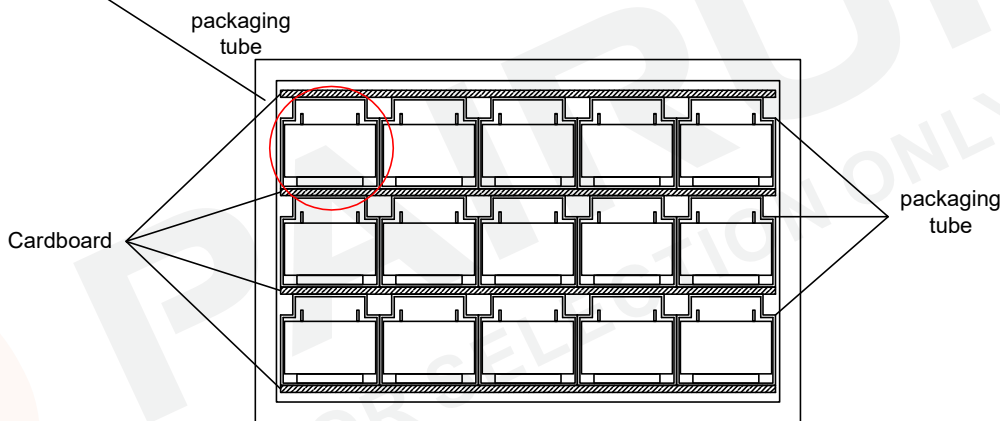

Carton Box Side View

Layer/Carton	Quantity/Tube (pcs)	Quantity/Carton (pcs)	Net weight (g/pc)	Gross weight (g/tube)	Tubes/carton (pcs)	Total weight (kg)	box size Dimensions (mm)
3.0	15.0	225.0	70.0	94.56	15.00	17.80	488*195*130

REV	DESCRIPTION	APPD	DATE

Tianchang Fuan Electronic Co Ltd
www.fuantronics.net
TEL: +86-550-7814888
FAX: +86-550-7831133



Tolerances unless otherwise specified:
(.X)±0.50 (.XX)±0.25
Unit of measurement: mm

Make: Qiumei.Liu
Checked: Beson. zhan
Approved: Anson. zhan

DRAWING TITLE
1.50W Encapsulated Transformer
For EI30*10.5,115VAC Input 50/60Hz
Material Number: A223010XS870

Customer Name:
Document/Rev: 00
Specification Sheet: 3 of 3
Date of Recognition: Jan./02/2020