

P/N: FAPE3010156

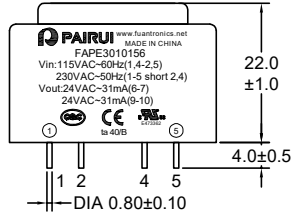

Outline Dimensions(Unit:mm)



Front View

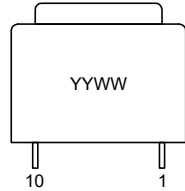

Side View

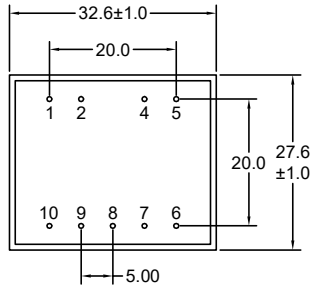

Bottom View

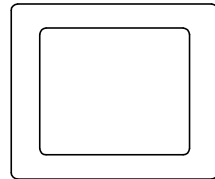

Top View

Note:

- 1.Remove Pins 3.

Wave Soldering



- Note:
- 1.Never Contact the ceramic with the iron tip;
 - 2.1.0mm tip diameter(max).

Electronical Schematic

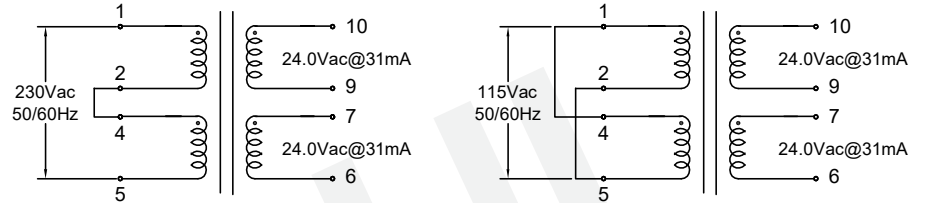

Electrical Characteristics

- Input 230Vac 50Hz to (1-5 short2,4)
- or Input 115Vac 60Hz to (1,4-2,5):
- Excitation current(Ix):12.0mA Max.
- Output: Vo6-7=43.3Vac Typ(No-load).
- Vo9-10=43.3Vac Typ(No-load).
- VL(6-10 short7,9)=48.0Vac±5%(Series @31mA).
- VL(6,9-7,10)=24.0Vac±5%(Parallel@62mA).
- Insulation Resistance: Pri-Sec:100 Mohms Min @500V.
- Hi-Pot: Pri-Sec:4000VAC/5mA/60Second.

General Properties

- Operating Temperature:-25°C to +40°C.
- Storage Temperature:-25°C to +85°C.
- Insulation Class: B.

| | | | | | | | | |
|-----|-------------|------|------|---|---|---|---|--|
| REV | DESCRIPTION | APPD | DATE | Tianchang Fuan Electronic Co Ltd www.fuantronics.net TEL: +86-550-7814888 FAX: +86-550-7831133 | Tolerances unless otherwise specified: (X)±0.50 (XX)±0.25 Unit of measurement: mm | Make: Qiumei.Liu Checked: Beson. zhan Approved: Anson. zhan | DRAWING TITLE 1.50W Encapsulated Transformer For EI30*10.5,2*115VAC Input 50/60Hz Material Number: A223010XS1H0 | Customer Name: Document/Rev: 00 Specification Sheet: 1 of 3 Date of Recognition: Jan./02/2020 |
|-----|-------------|------|------|---|---|---|---|--|

P/N: FAPE3010156

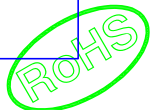

List of UL Certificate:

| No. | Part Name | Mat'l Description | Supplier | UL Number |
|-----|-------------|-----------------------------|-------------------------------------|-----------|
| 1 | Bobbin | EI30*10.5/PBT(Black) | Chang Chun Plastics Co Ltd | E59481 |
| 2 | Case | CASE-EI30*10.5/PA66(Orange) | Zhejiang Juner New Materials Co Ltd | E204321 |
| 3 | Copper wire | 2UEW-F/155C | Elektrisola Hangzhou Co Ltd | E258243 |
| 4 | Core | Lamination | Ta Yea Steel Industry Co Ltd | N/A |
| 5 | Epoxy | PU552(Black) | Wevo-Chemle Gmbh | E108835 |
| 6 | | | | |

Packaging Specification:

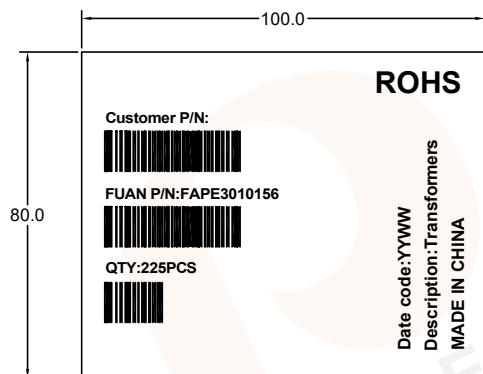

Label of outer

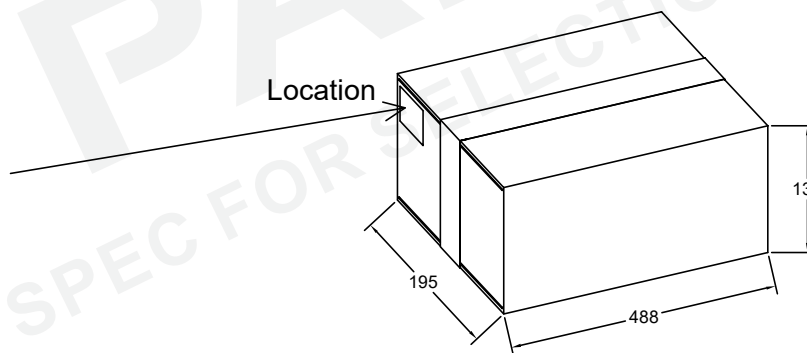

put the label on the top left corner of one of the carton sides

| | | | | | | | | |
|-----|-------------|------|------|---|--|---|---|--|
| | | | | Tianchang Fuan Electronic Co Ltd www.fuantronics.net TEL: +86-550-7814888 FAX: +86-550-7831133 | Tolerances unless otherwise specified: (.X)±0.50 (XX)±0.25 Unit of measurement: mm | Make: Qiumei.Liu Checked: Beson. zhan Approved: Anson. zhan | DRAWING TITLE 1.50W Encapsulated Transformer For EI30*10.5,2*115VAC Input 50/60Hz Material Number: A223010XS1H0 | Customer Name: Document/Rev: 00 Specification Sheet: 2 of 3 Date of Recognition: Jan./02/2020 |
| REV | DESCRIPTION | APPD | DATE | | | | | |

P/N: FAPE3010156



Packing Method:

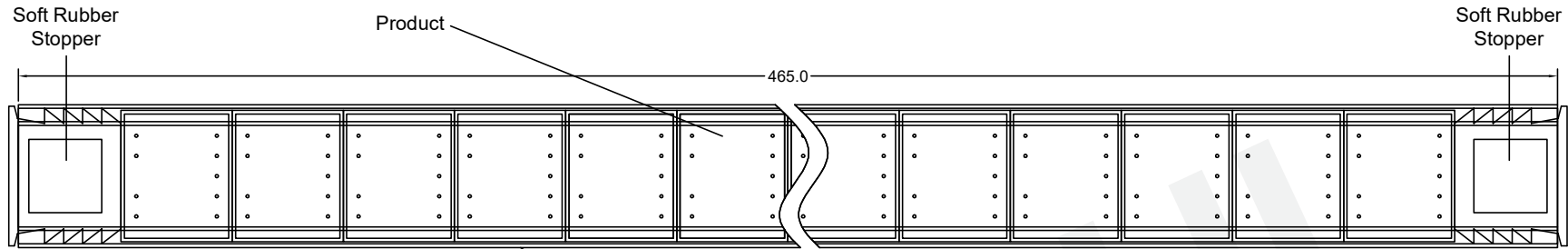

Size of packaging tube:
465mm*35.4mm*32.7mm
(Length * Width * Height)

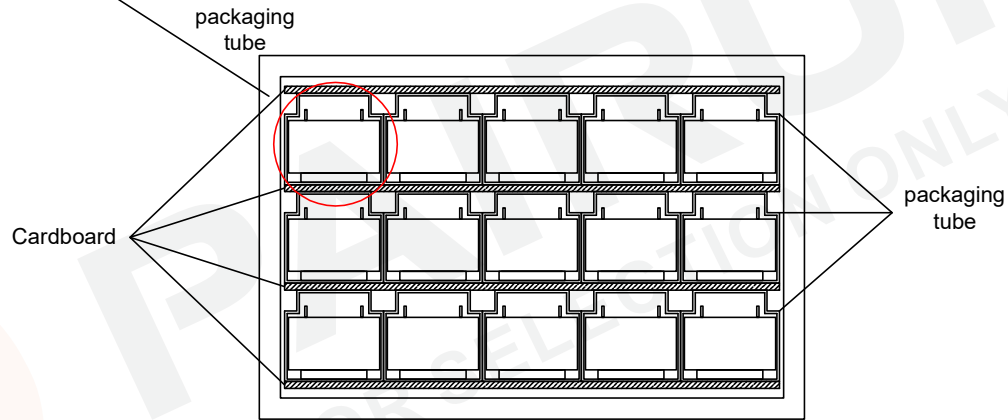

Carton Box Side View

| Layer/Carton | Quantity/Tube (pcs) | Quantity/Carton (pcs) | Net weight (g/pc) | Gross weight (g/tube) | Tubes/carton (pcs) | Total weight (kg) | box size Dimensions (mm) |
|--------------|---------------------|-----------------------|-------------------|-----------------------|--------------------|-------------------|--------------------------|
| 3.0 | 15.0 | 225.0 | 70.0 | 94.56 | 15.00 | 17.80 | 488*195*130 |

| | | | | | | | | |
|-----|-------------|------|------|---|--|---|---|--|
| | | | | Tianchang Fuan Electronic Co Ltd www.fuantronics.net TEL: +86-550-7814888 FAX: +86-550-7831133 | Tolerances unless otherwise specified: (.X)±0.50 (.XX)±0.25 Unit of measurement: mm | Make: Qiumei.Liu Checked: Beson. zhan Approved: Anson. zhan | DRAWING TITLE 1.50W Encapsulated Transformer For E130*10.5,2*115VAC Input 50/60Hz Material Number: A223010XS1H0 | Customer Name: Document/Rev: 00 Specification Sheet: 3 of 3 Date of Recognition: Jan./02/2020 |
| REV | DESCRIPTION | APPD | DATE | | | | | |