

P/N: FALCH1014-121K2R3-□

Outline Dimensions(Unit:mm)

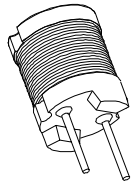
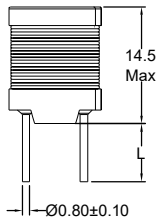

Pins Lead(L):

|     |          |
|-----|----------|
| -5  | 5.00±1.0 |
| -10 | 10.0±2.0 |
| -15 | 15.0±3.0 |

FALCH1014-121K2R3-5  
 FALCH1014-121K2R3-10  
 FALCH1014-121K2R3-15

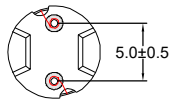
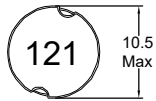

Electronical Schematic

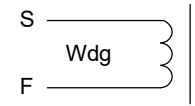

Electrical Characteristics(@25°C)

| Inductance<br>1KHz,0.3V | DC Resistor | Temp.<br>40°C | Lldc: 1KHz,0.3V |          |          |
|-------------------------|-------------|---------------|-----------------|----------|----------|
|                         |             |               | 10% drop        | 20% drop | 30% drop |
| 120uH±10%               | 135mΩ Max   | 2300mA        | 2700mA          | 3200mA   | 3500mA   |

\*\*\*Operating Temperature: -40°C~+125°C.  
 (Temperature rise included)  
 \*\*\*Storage Temperature : -40°C~+125°C.  
 \*\*\*Storage Humidity:RH10%~70%.

Recommended Soldering Temperature Graph.

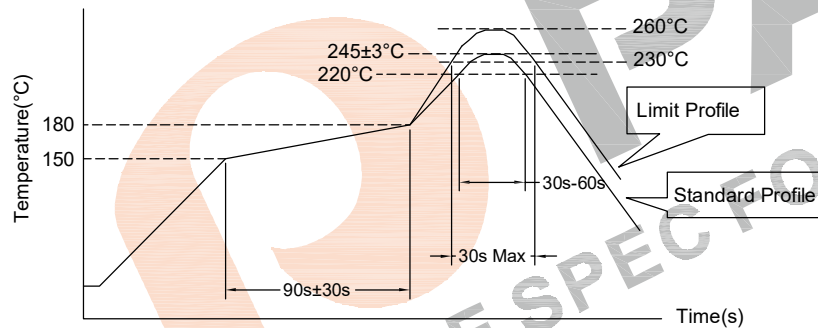

|                  | Standard Profile    | Standard Profile    |
|------------------|---------------------|---------------------|
| Pre-heating      | 150~180°C,90s±30s   |                     |
| Heating          | above 220°C,30s-60s | above 240°C,30s Max |
| Peak temperature | 245°C±3°C           | 260°C,10s           |
| Cycle of reflow  | 2 times             | 2 times             |

Simulation test curve:

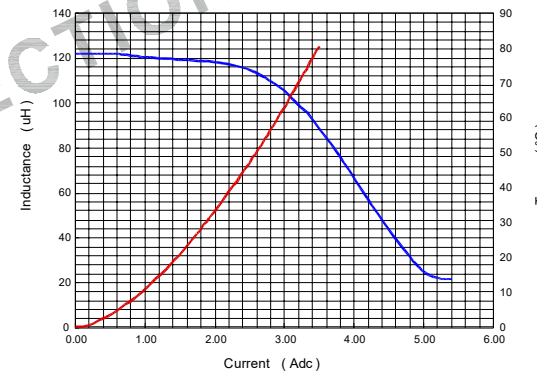

Material list

| Part Name | SPEC                    | Supplier                              | UL Number |
|-----------|-------------------------|---------------------------------------|-----------|
| Core      | DR2W10*14RF(B=5.4)-NiZn | LiCheng Electronic(ZhangZhou) Co.,Ltd | N/A       |
| Wire      | 2UEW-F/155°C            | ShangDong Saint Electric Co.,Ltd      | E194410   |

Tianchang Fuan Electronic Co Ltd  
 www.fuantronics.net  
 TEL: +86-550-7814888  
 FAX:+86-550-7831133

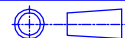

Tolerances unless otherwise specified:  
 (.X)±0.50 (.XX)±0.25  
 Unit of measurement: mm

Drawn: *June*  
 Checked: *Benson*  
 Approved: *AmSon*

**DRAWING TITLE**  
 DR2W10\*14RF RADIAL FILTER CHOKE  
 Material Number:

Customer Name:  
 Document/Rev: 2211228/00  
 Specification Sheet: 1 of 1  
 Date of Recognition: Nov./08/2022

| REV | DESCRIPTION | APPD | DATE |
|-----|-------------|------|------|
|     |             |      |      |