

P/N: FALCHB1622-151K4R0-□

### Outline Dimensions(Unit:mm)

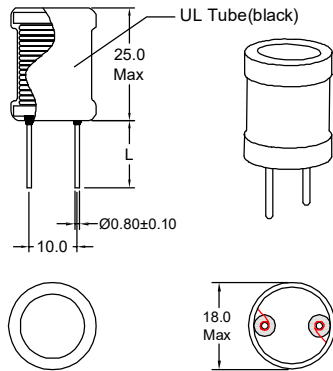

Pins Length(L):

-5	5.00±1.0
-10	10.0±2.0
-15	15.0±3.0

FALCHB1622-151K4R0-5  
FALCHB1622-151K4R0-10  
FALCHB1622-151K4R0-15

REMARK:

1. Products need thermal shrinkable sleeve.

### Electronical Schematic

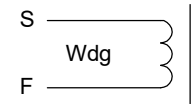

### Electrical Characteristics(@25°C)

Inductance 1KHz,0.3V	Lldc 1KHz,0.3V	Temp. 40°C	DC Resistor	Rated Current
150uH±10%	>90%*LOA	4200mA	85.0 mΩ Max	4000mA

- \*\*\*Operating Temperature: -40°C~+125°C.  
(Temperature rise included)
- \*\*\*Storage Temperature : -40°C~+125°C.
- \*\*\*Storage Humidity:RH10%~70%.

### Recommended Soldering Temperature Graph.



	Standard Profile	Standard Profile
Pre-heating	150~180°C,90s±30s	
Heating	above 220°C,30s-60s	above 240°C,30s Max
Peak temperature	245°C±3°C	260°C,10s
Cycle of reflow	2 times	2 times

### Simulation test curve:

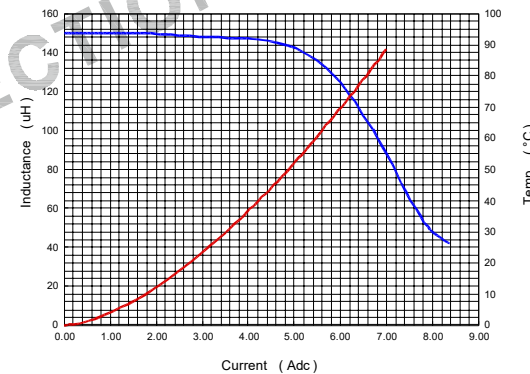

### Material list

Part Name	SPEC	Supplier	UL Number
Core	DR2W16*22(B=10)-MgZn	LiCheng Electronic(ZhangZhou) Co.,Ltd	N/A
Wire	2UEW-F/155°C	ShangDong Saint Electric Co.,Ltd	E194410
Tube	Heat shrinkable casing/125°C	Changyuan Electronics (Shenzhen) Co Ltd	E180908

Tianchang Fuan Electronic Co Ltd  
www.fuantronics.net  
TEL: +86-550-7814888  
FAX:+86-550-7831133

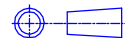

Tolerances unless otherwise specified:  
(.X)±0.50 (XX)±0.25  
Unit of measurement: mm

Drawn: *June*  
Checked: *BenSon*  
Approved: *AmSon*

**DRAWING TITLE**  
DR2W16\*22 RADIAL FILTER CHOKE  
Material Number:

Customer Name:  
Document/Rev: 2210420/00  
Specification Sheet: 1 of 1  
Date of Recognition: Oct./28/2022

REV	DESCRIPTION	APPD	DATE