

PRODUCT SPECIFICATION

Product Model: PXF60W-200-C0350-K-F

Version Number: V3.0

Created	Validated	Approved
Chunshui Xie	Joe Wang	Pengfei Yin

Version	Description of change	Date
V3.0	1.PF range changed. 2.Safety Compliance updated.	2023.05.31

PXF series drive is a high performance LED drive power supply with miniaturization, constant current output control and non-isolation, high power factor, low THD, low output ripple. CCT Switch Concept, The CCT versions have like 2 channel output.

Key Features

- Drive Mode: Flicker-Free Constant Current.
- Technology: 2-Stage PFC + Buck technology.
- Input Voltage: 220 to 240VAC (maximum: 198-264 VAC)
- Frequency: 47-63Hz
- Output Power: 60Watt Max.
- Output Voltage: 84Vdc to 200Vdc.
- Output Current: 200mA to 350mA.
- Efficiency: Up to 91%.
- Warranty: 5 years.

Special Features

- Constant Current, Current selection 4 steps, 50mA.
- A rated lifetime of 50,000 hours @ Tc = 75 °C.
- Non-isolated power.
- Safety: GB 19510.1-2009; GB 19510.14-2009; EN 61347-1: 2015, EN 61347-2-13: 2014, EN 61347-2-13/A1: 2017; EU 2019/2020.
- EMC: GB 17625.1-2012; GB/T 17743-2021; EN 55015; EN 61547; EN 61000-3-2; EN 61000-3-3; EN 61000-4-4; EN 61000-4-5.
- Surge: line to line 1KV/2Ω 8/20 us, line to earth 2KV/12Ω 8/20us.
- Metal shell. Meet the RoHS directive.
- IP20, Compliant for Dry, Damp.

Main Electrical Specification

No.	Part Number	Output Power	Output Voltage	Output Constant Current	Current Accuracy	Max. Eff.	ErP	CE	ENEC	CCC	CB
1	PXF60W-200-C0350-K-F	60W	84-200Vdc	200-350mA	±7.5%	91%	Yes	Yes	Yes	Yes	Yes

Note:

- Maximum efficiency measured at 230VAC input, Current set at 350mA full load.

Input Specifications

Parameter	Min.	Typ.	Max.	Notes /Conditions
Input Voltage	198Vac	---	264Vac	220, 230, 240Vac Nominal Values

Enclosure

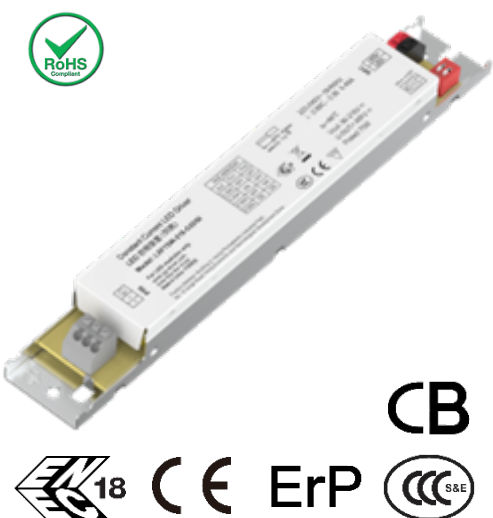

Size	Unit	Inch	Millimeter
Case Length		82.68	210.0
Case Width		1.18	30.0
Case Height		0.83	21.0
Mounting Length		7.80	198.0

Input Frequency	47Hz	50/60Hz	63Hz	50/60 Hz Nominal
Standby Power			0.5W	No-load.
Leakage Current	---	---	450 μ A	Measured at 230Vac / 60Hz Input, Output Full Load.
THD	---	---	20%	Measured at 230Vac Input, Output Full Load
Power Factor (PF)	0.8C	---	0.95	Measured at 220,230,240Vac Input.

Parts list

Parameter	Min.	Typ.	Max.	Notes /Conditions
Input AC Current	---	---	0.36A	Measured at 230Vac / 50Hz Input, Output Full Load.
Inrush Current (Peak)	---	31A / 176us	---	Pulse width Measured at 50% Ipeak & 240Vac / 50Hz Input, Output Full Load.

Output Specifications

Parameter	Min.	Typ.	Max.	Notes /Conditions
Output Constant Current	-7.5%	Per Table	+7.5%	Per Tables on Page 1
Current selection	---	200mA	---	Pin1-OFF, Pin2-OFF.
	---	250mA	---	Pin1-ON, Pin2-OFF.
	---	300mA	---	Pin1-OFF, Pin2-ON.
	---	350mA	---	Pin1-ON, Pin2-ON.
Output LF Current Ripple (<120 Hz)	-5%	---	+5%	20MHz BW, Measured at 230Vac / 50Hz Input, Output Full Load. Ripple Index is defined as $[(Y_{max}-Y_{min})/Y_{mean}]/2 * 100\%$. Y may be V or I.
Fulfill TLA	PstLM<1, SVM<0.4			With specified LED load and full load.
Line Regulation	-3%	---	+3%	Measured at 220, 230, 240Vac / 60Hz Input, Output Full Load
Load Regulation	-4%	---	+4%	Measured at 220, 230, 240Vac / 60Hz Input
Start-up Time	---	200ms	500ms	Measured at 230Vac / 60Hz Input, Output Full Load
Output Overshoot	-2%	---	+10%	Measured at 220, 230, 240Vac Input, When power on or off

Parts list

Part Number	PXF60W-K			
Output Current	200mA	250mA	300mA	350mA
Vf min	84Vdc	84Vdc	84Vdc	84Vdc
Vf max	200Vdc	200Vdc	200Vdc	175Vdc
Pomin	16.8W	21W	25.2W	29.4W
Pomax	40W	50W	60W	61.25W
Max U-OUT	250Vdc			

CCT Switch Concept

Take 350mA version for example:	Channel #1 (LED- WW terminal)	Channel #2 (LED- CW terminal)
WW(warm white, eg-3000K)	350mA	Off

NW(warm white, eg-4000K)	175mA	175mA
CW(warm white, eg-6500K)	Off	350mA

Protection Specifications

Parameter	Min.	Typ.	Max.	Notes /Conditions
Output Short Circuit (SCP)	---	---	---	No Damage. Auto recovery after short is removed.
Output Over Current (OCP)	---	---	+10% Io	Constant Current Limiting circuit.
Output Over Voltage (OVP)	---	---	120% Vo	No Damage. Auto recovery after short is removed.
Over Temp Protection(OTP)	95°C	100°C	110°C	lout Foldback at Tc>95°C, lout to off @ Tc~110°C

General Specifications

Parameter	Typ.	Notes /Conditions
Cooling	Convection	
MTBF	350,000 hours	Measured at 230Vac input, 100%Load and Ta=25°C(MIL-HDBK-217F).
Life Time	50,000 hours	Measured at 230Vac input, 100%Load and TC=75°C
Product Noise	< 24db	Class A, Not to exceed at 1 meter at any dim level.

Environmental Specifications

Parameter	Min.	Typ.	Max.	Output Power	Notes /Conditions
Operating Temperature (Ta)	-20 °C	---	+60°C	---	@230Vac. This is a reference range. Tc controls temperature range.
Case Temperature (Tc)	-20 °C	---	+80°C	60W	Measured at location specified on case.
Storage Temperature (Ts)	-40°C		+80°C	---	Non operating temperature range.
Operating Humidity	5% RH	---	85% RH	---	Relative Humidity. Non-condensing.
Vibration	5 Hz	---	55 Hz	---	2G, 10 minutes / 1 cycle, period 30 minutes, each along X, Y, Z axis.

Safety Compliance

Safety Category	Standards / Notes
CCC	GB 19510.1-2009; GB 19510.14-2009.
CE	EN 61347-1:2015, EN 61347-2-13:2014, EN 61347-2-13/A1:2017
ErP 2.0	EU 2019/2020
Enclosure / Ground - output	1.5KVac 3S
Isolation Resistance	Input to PE/Housing: >10MΩ, 500Vdc @ 25°C, 70% RH.
FG	The metal case of the driver must be connected to earth ground (FG) in the end-use application.

EMC Compliance

EMI Category	Standards
GB 17625.1-2012	Emc, limits, harmonic current emission values (equipment input current per phase < 16A)
GB/T 17743-2021	Radio disturbance characteristics of electrical lighting and similar equipment limits and measurement methods
EN 55015	Conducted emission Test & Radiated emission Test
EN 61547	Electromagnetic Immunity Requirements Applies To Lighting Equipment
EN 61000-3-2	Harmonic current limits

EN 61000-3-3	Limits on voltage fluctuations and flickering (Rated current <16A)
EN 61000-4-4	Electrical Fast Transient / Burst-EFT. No Flicker / Restart 2KV.
EN 61000-4-5	Surge Immunity Test: AC Power Line: line to line 1KV/2Ω 8/20us, line to earth 2KV/12Ω 8/20us.

Note: The above test data are in the condition of 25°C ambient temperature, except for the marked temperature.

Typical Applications

■ Constant Current Driver

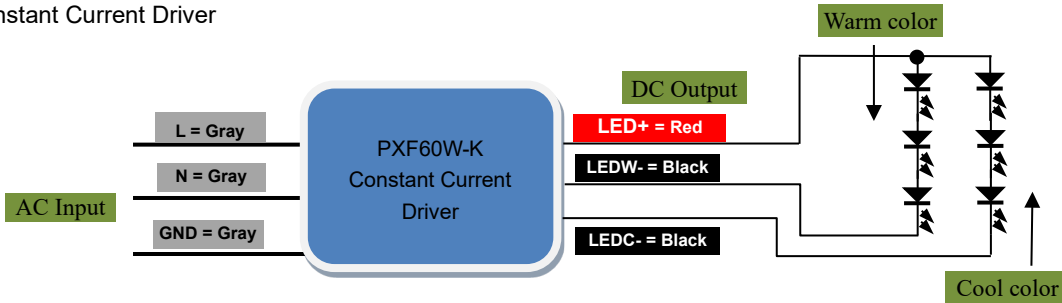

Characteristic Curve

Typical Efficiency vs Vout at 25°C Ambient Temp

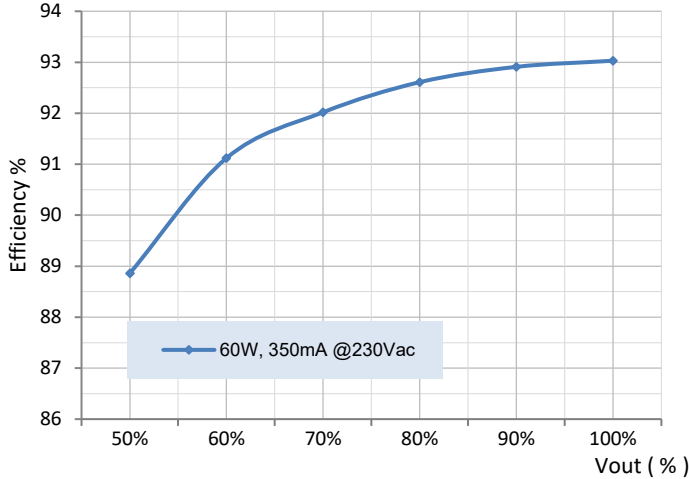

Typical PF vs Vout at 25°C Ambient Temp

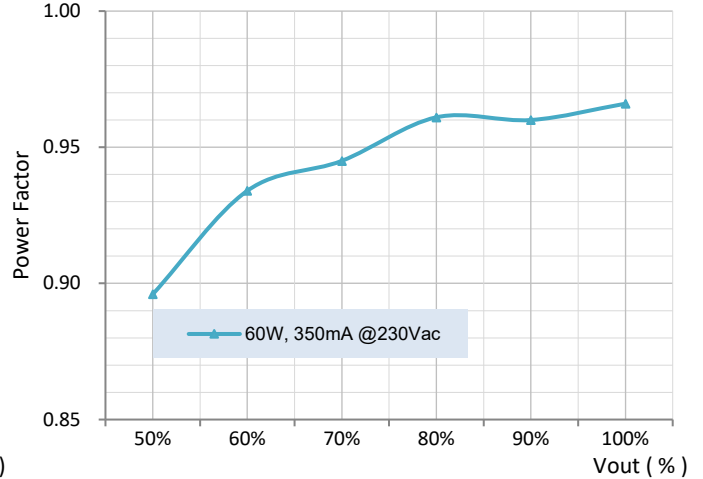

Typical THD vs Pout at 25°C Ambient Temp

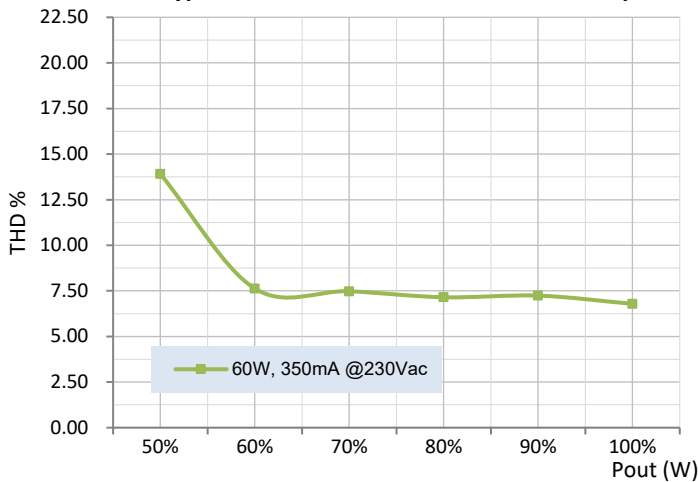

Lifetime Curve

Life Time vs Tc Temp

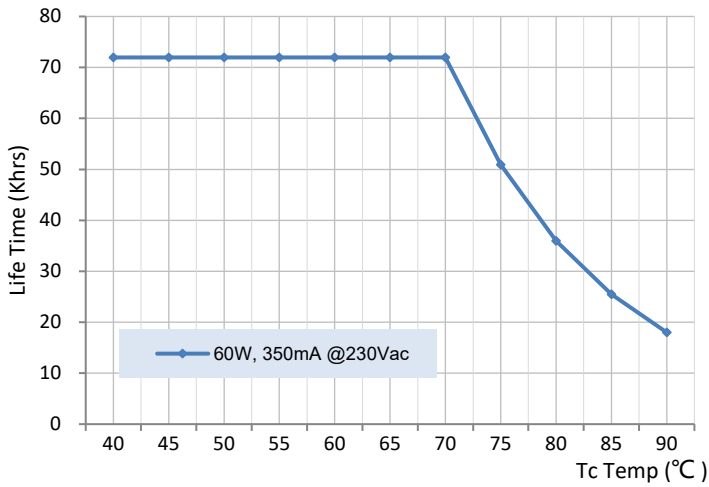

Installation

- AC input wires cross section: 0.75~1.5mm².
- DC output wires cross section: 0.75~1.5mm².

This product for indoor use only, it can be installed and fixed in the luminaires, connected with the wire. The length of output line should be less than 2m.

Order ID

P/N: PXF60W-175-C0350-K (Pin1-ON, Pin2-ON.)

Description: 60W, 175Vdc voltage max, constant current 350mA, constant current mode.

Product Size

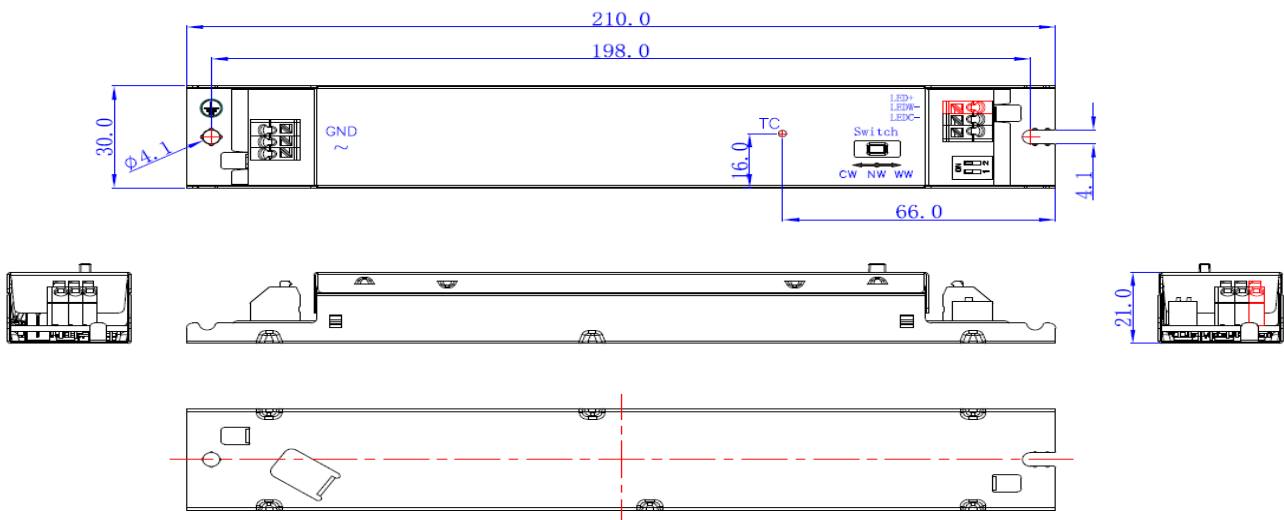

Note:

- The independent LED drive conforms to the EMC standard. But it is not guaranteed to be qualified when the drive is mounted in the LED fixture.
- Please forgive us for any discrepancy due to the update of the specifications or the upgrade of the product. If you need the latest information, please contact our marketing department.